



Dental Instruments Catalog 2026

HiTeck
Your Partner in Dentistry



YOUR FAVOURITE INSTRUMENT BRAND



HiTeck is one of Canada's leading providers of dental instruments and sterilization cassettes, trusted by more than 10,000 dental offices across North America. We're dedicated to delivering premium quality instruments and exceptional customer service, making HiTeck the top choice for dental practices seeking reliable, high performance solutions.

To Our Valued Customers

Over the past decade, we've proudly guided HiTeck to new heights by delivering innovative dental instruments to professionals around the world. On behalf of our entire global team, thank you for trusting us with your instrument needs. We remain committed to constant growth and innovation, making dentistry simpler by serving as a true partner to our customers.

I'm thrilled to introduce our 2025 Product Catalog, showcasing a wide range of new, cutting-edge solutions. We look forward to continuing our shared journey of advancing dentistry and improving patient care. Thank you for your ongoing support, and we can't wait to see what we'll accomplish together.

Sincerely,

HASSAN TUFAIL
CEO

TABLE OF CONTENTS

INTRODUCTION

4-5 Services Offered

6-7 Our History

8-9 Manufacturing & Quality

SURGICAL

12-15 Extraction Forceps

16-19 Elevators

19-21 Luxating Elevators

22 Scissors

23-24 Needle Holders

25 Aspirators & Bone Rongeurs

26 Calipers & Hemostats

27 Dressing & Tissue Pliers

28-29 Periosteals

30 Periostomes & Root Tip Picks

31-32 Retractors

32-33 Scalpel Handles & Bone Files

34 Surgical Curettes & Bone Chisels

35 Perio Surgery & Tunneling

36 Bone Osteotomes

37 Ridge Split Chisels & Mallet

DIAGNOSTIC

40 Mirrors, Handles & Tweezers

41 Explorers

42 Expos

43 Probes

PERIODONTAL

46-47 Sickle Scalars

48 Universal & Area Specific Curettes

49-50 Gracey Curettes

51 Titanium Implant Curettes

ENDODONTIC

54 Explorers, Pluggers, Excavators

55 ISO & LUKS Pluggers

56 Root Fragment Forceps

57 Rubber Dam Forceps, Frames, Punch

58-59 Rubber Dam Clamps

RESTORATIVE

62 PKT & Measuring Instruments

63-66 Composite Instruments (PFI)

67 Hatchets, Margin Trimmers & Chisels

68-69 Excavators

70 Pluggers

71 Amalgam & Crown Removers

72 Burnishers & Spatulas

73 Carvers

ORTHODONTIC

76 Clear Aligner Instruments

77 Cutters

78 Utility Pliers

79 Wire Forming Pliers

80 Photography Mirrors

81 Hand Instruments

INSTRUMENT MANAGEMENT

84-91 Sterilization Cassettes

SERVICES OFFERED

OUR SERVICES

Apart from providing quality products, HiTeck focuses on providing the best in industry services to its customers.

INFECTION CONTROL GUIDANCE

Infection control in a clinic is very important. Proper infection control minimizes cross contamination and increases a patient's trust in their doctor. We have a number of products available for proper infection control, and also provide guidance on a regular basis to our clients who might have some questions on how to store, sterilize and maintain products properly.

PRODUCT SOURCING & CONSULTATION

With our product sourcing & consultation service, we make it easier for our customers to choose the right product for the right procedure. With too many options in the market, it can sometimes become confusing to choose the right product. We also help our customers source a product that they need to get for their procedure. Contact us to find out more about our sourcing & consultation service.

NEW PRODUCT DESIGN

Due to new research and advancement in the medical field, it is very important to keep on introducing new and better products into the market. We routinely work with our customers to bring new and improved products to the market. If you have a concept of a revolutionary product or have modification suggestions to an existing product, please contact us.

PROPER REPROCESSING TECHNIQUES

Proper instrument reprocessing can significantly increase the life of the product. We continually work with our customers to educate them on the proper technique to reprocess their instruments on a daily basis, so that they may maintain the integrity of the products. For more information, please visit our reprocessing page, or contact us.

HITECK'S CONCIERGE SERVICE

TRY OUR INSTRUMENTS AT
THE COMFORT OF YOUR OFFICE.

LET US EXPLAIN HOW THE
WHOLE PROCESS WORKS.



FREE SHIPPING

We can ship all over Canada & USA!



EASY RETURNS

Return Label included in the box!



NO COMMITMENT

You can send everything back, anytime!

1

FILL OUT OUR REQUEST FORM

Enter your details, the sample categories you would like to see. You can also mention specific products that you are interested in.

2

GET INSTRUMENTS TO YOUR DOOR!

Sit back and relax, your package is on its way to your doorstep. Now you can browse through our products at the comfort of your office at the time of your choosing.

3

CHOOSE THE AMOUNT OF TIME REQUIRED

Mention the time you will need to keep the samples with you in order to evaluate. We will include a return label with the instruments.

THE HISTORY

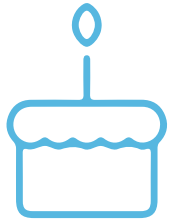

1982

Birth

Began as an OEM manufacturer of medical devices for international brands, producing only a handful of SKUs.

Office in Germany

After 11 years of OEM manufacturing, we established a local branch in Tuttlingen, Germany. This strategic location allowed us to expand our reach to clients in Africa and the Middle East, while partial manufacturing processes began in Germany.

1993

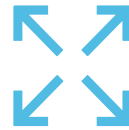
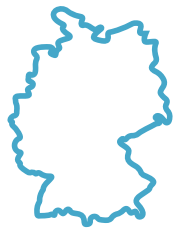

2002

Product Range Extended

We broadened our expertise to cover all surgical specialties, growing our catalog to 50,000 different types of surgical instruments.

Started in Canada

Opened our first branch under our own brand in Canada. Instead of selling only OEM products, we began supplying our branded instruments directly to dental professionals across North America.

2009



20

Lauriya Line Instruments

Introduced specialized coating that enhances durability, sharpness, and provides superior resistance to wear and corrosion.

OF HITECK

Sterilization Cassettes

Debuted a wide variety of customizable sterilization cassettes, improving reprocessing efficiency and helping to prevent sharp injuries.



Implant & Specialized Oral Surgery Instruments

Expanded into implant-related solutions, offering implant scalers, chisels, osteotomes, ridge Split instruments, and more for successful implant procedures.



2012

2013

2018

2022

NOW TO THE FUTURE

Launched the of instruments

and a
black
that
visibility,
and
s. The
sh
flare,
contrast,
less
resistance
and

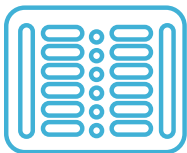

Orthodontic Range Added

Rolled out a comprehensive suite of orthodontic instruments, ensuring practitioners have all the essential tools for orthodontic care.



We're gearing up for major advancements, from introducing new and innovative products to launching operations in the USA—continuing our mission to equip professionals with cutting-edge, high-quality instruments.



MANUFACTURING QUALITY INSTRUMENTS SINCE 1982

By leveraging state-of-the-art technology and meticulous processes, we ensure every instrument meets the highest standards. Our commitment to excellence in manufacturing naturally results in superior quality products.

MANUFACTURING PROCESSES

Each instrument is carefully crafted through approximately 30 precise manufacturing processes, ensuring every detail meets our high standards of quality and performance. From forging, filing, and tempering to shaping, polishing, and final inspection, each step receives our focused attention—delivering unmatched reliability, durability, and precision.

PRECISION CRAFTSMENSHIP

All instrument are meticulously forged, filed, tempered, shaped, and polished by skilled artisans, ensuring an unparalleled level of accuracy, durability, and reliability.

INNOVATIVE DESIGN



Combining ergonomic design with cutting-edge innovation, our instruments are tailored for optimal performance and user comfort. We continually push the boundaries to provide advanced solutions for modern dental practices.

QUALITY TESTING PROTOCOLS

All instruments undergo rigorous testing protocols to ensure they meet the highest industry standards. Our comprehensive quality assurance process guarantees reliability, safety, and superior performance.

EXTENSIVE PRODUCT PORTFOLIO

Our broad range includes over 15,000 meticulously designed instruments, ensuring comprehensive solutions for all dental procedures and needs

DEDICATED WORKFORCE

Our team of highly skilled professionals is committed to excellence, ensuring that each instrument meets our rigorous standards for quality and precision.

Our extensive range of premium dental surgical instruments is meticulously crafted to deliver precise, reliable performance—even under the most demanding conditions. By blending traditional handcrafting expertise with advanced technology, top-tier materials, and stringent quality control, we create instruments that empower clinicians to offer the highest standard of care to their patients.

SURGICAL SIYAH LINE

Designed for performance & Durability, our Siyah line of surgical instruments are engineered with Aluminum Titanium Nitride to optimize clinical outcomes. From reducing light reflection to enhancing visibility at the surgical site, the Siyah line was created with the clinician in mind.

Reduced Light Reflection

Matte-finish handles and black working ends minimize glare for improved visibility.

Enriched Contrast

Distinct black finish gives better contrast and visual acuity at the surgical site & underlying tissue

Ergonomic Design

The smooth, large-diameter, lightweight handle offers maximum comfort, reduces hand fatigue, and enhances control.

Hardened Steel Construction

Ensures optimal strength and corrosion resistance.

TYPES OF SCISSORS

Stainless steel

A wide array of cutting blades to fit a variety of

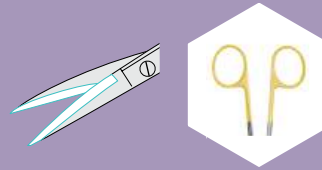

Tungsten Carbide (TC)

Featuring Tungsten Carbide inserts bonded to surgical grade stainless steel on both cutting edges for smooth, controlled cutting & maximum durability. Blade lasts 4 times longer

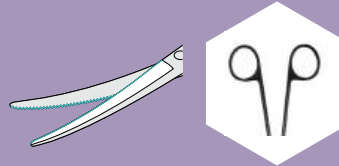

Siyah Super Cut with Tungsten Carbide (TC)

Best of the bunch, featuring a performance engineered coating for optimal edge retention, reduced light reflection afforded by the matte finish, and enriched contrast and visual acuity at the surgical site

Edge Retention

AlTiN coating increases hardness of steel resulting in better edge retention of the blade

Performance-Engineered Coating

Delivers a harder, smoother surface for superior edge retention and enhanced lubricity.

SURGICAL

BEAKS OF EXTRACTION FORCEPS

The beaks of extraction forceps are anatomically designed to adapt to the tooth at or below the cervical line. Therefore, beaks are either conical, bifurcated, or trifurcated in order to adapt to the tooth or furcations.

Many beaks are serrated, which offers additional grasp when extracting teeth.

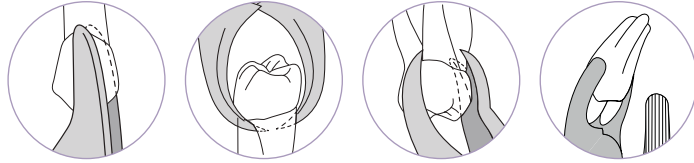

CONICAL BIFURCATED TRIFURCATED SERRATED

Care of HiTeck Extraction Forceps

Make sure following steps are performed to maintain proper function and appearance:

- Clean and sterilize in an open position.
- Clean and thoroughly dry forceps before wrapping for sterilization.
- Lubricate with Instrument Lubricant after cleaning and before sterilization to ensure smooth working action.
- Use wipes to correct hard-to-operate forceps. Rust spots or sediment can be wiped off, as they do not penetrate the surface.
- Do not allow forceps to remain in water or steam moisture for long periods.
- Keep forceps away from strong mineral acids and fumes.

TYPES OF FORCEPS

DIAMOND DUSTED FORCEPS

Featuring a fine diamond coating for enhanced grip and control, these forceps provide superior tooth engagement. Available in multiple patterns for full-mouth coverage.

KUMANI FORCEPS

Designed with an internal spring hinge for smooth handling, ensuring precision, comfort, and control while minimizing forceps manipulation at the surgical site.

APICAL FORCEPS

Forged with thin, tapered beaks and longitudinal serrations for a secure multi-point grip, reducing crown fractures and preserving bone integrity during extractions.

ATRAUMAIR FORCEPS

Matte-finished for reduced glare, these lightweight forceps feature enhanced beak geometries and an ergonomic hole design for improved access, comfort, and control.

STANDARD FORCEPS

Crafted from high-quality stainless steel, these forceps ensure strong grip, optimal leverage, and versatility for routine extractions in various clinical applications.

APICAL FORCEPS



AF1 Standard Apical
Upper Anteriors
2524 | \$164.99



AF150 Apical
Upper Universal
2525 | \$164.99



AF151 Apical
Lower universal
2526 | \$164.99



AF222 Apical
Lower Molars
2527 | \$164.99



AF67A Apical
Upper Molars
2528 | \$164.99



AF74N Apical
Lower Anteriors
2529 | \$164.99



21 Atraumair
1st & 2nd Upper Molars
F21XS \$184.99
F21XSD \$299.99
Diamond Coated



44 Atraumair
Upper Roots
FX44XS \$184.99
FX44XSD \$299.99
Diamond Coated



67 Atraumair
Upper Molars
F67XS \$184.99
F67XSD \$299.99
Diamond Coated



1 Atraumair
Upper Incisors
F1XS \$184.99
F1XSD \$299.99
Diamond Coated



1 Apical Atraumair
Upper Incisors
FAF1XS \$184.99
FAF1XSD \$299.99
Diamond Coated



35 Atraumair
Upper Canines & Premolars
F35XS \$184.99
F35XSD \$299.99
Diamond Coated



36 Atraumair
Lower Incisors
F36XS \$184.99
F36XSD \$299.99
Diamond Coated



36 Apical Atraumair
Lower Premolars & Incisors
FAF36XS \$184.99
FAF36XSD \$299.99
Diamond Coated



13 Atraumair
Lower Premolars
F13XS \$184.99
F13XSD \$299.99
Diamond Coated



73 Atraumair
Lower Molars
FX73XS \$184.99
FX73XSD \$299.99
Diamond Coated



79 Atraumair
Lower Molars
FX79XS \$184.99
FX79XSD \$299.99
Diamond Coated



51 Atraumair
Upper roots, serrated
FX51XS \$184.99
FX51XSD \$299.99
Diamond Coated



23 Cowhorn Atraumair
Lower Molars
F23XS | \$184.99



45 Atraumair
Lower Roots, Serrated
F45XS \$184.99
F45XSD \$299.99
Diamond Coated



35 Apical Atraumair
Upper Canines, Premolars & Molars
FAF35XS \$184.99
FAF35XSD \$299.99
Diamond Coated

The Siyah Deep Grip Forceps are coated with Aluminium Titanium Nitride that is significantly harder, scratch-resistant and non-reflective for long lasting performance.

Increased hardness ensures long-term integrity of both the beak serrations and forceps overall.

- Extremely smooth surface seals the pores of the stainless steel, minimizing protein adhesion and reducing time to clean.
- Matte finish that reduces distracting glare and reflections mid-procedure.
- Machined beaks give you precision and control over your extractions.

ATRAUMAIR FORCEPS



Upper Anterior
SEF902 | \$329.99



Upper Universal
SEF903 | \$329.99



Lower Universal
SEF904 | \$329.99



Universal Upper Molars
SEF905 | \$329.99



Lower Roots
Serrated spade tip
SEF908 | \$329.99



Upper Roots
Serrated spade tip
SEF909 | \$329.99



Lower Anterior
Lower anteriors
SEF906 | \$329.99



Lower Molars
Lower molars
SEF907 | \$329.99



222
Lower molars
1503 | \$154.99



3FS Woodward
Lower Molars
EF14 | \$154.99



217
Lower Molars
EF15 | \$154.99



MD4 Mead
Lower Molars
EF16 | \$154.99



62
Upper & Lower Incisors,
Canines & Premolars
1480 | \$154.99



101 Hull
Upper & Lower
Premolars
EF03 | \$154.99



151A Cryer Universal
Lower Incisors, canines
& premolars & roots
1499 | \$154.99



151AS Split Beak
Lower Incisors, canines
& premolars & roots
1501 | \$154.99



13 Serrated
Lower Premolars
1423 | \$154.99



151 Cryer Universal
Lower Incisors, canines
& premolars & roots
1498 | \$154.99



1 Serrated
Upper Anterior
1401 | \$154.99



2
Upper & Side Incisors
1402 | \$154.99



7 Serrated
Upper premolars
1403 | \$154.99



4
Lower Incisors & Canines
1422 | \$154.99



MD3 Mead Serrated
Lower incisors & roots
EF06 | \$154.99



203
Lower Incisors, Canines
& Premolars
EF13 | \$154.99



32 Parmlly
Upper Incisors & Canines
1478 | \$154.99



32A Parmlly
Upper Incisors & Canines
1479 | \$154.99



150 Cryer Universal
Upper Incisors & Canines
1487 | \$154.99



**150A Cryer Parallel
Beaks**
Upper Incisors & Canines
1488 | \$154.99



**150AS Split Beaks
Serrated**
Upper Incisors & Canines
1490 | \$154.99



1A Henahan
Upper Incisors & Canines
1474 | \$154.99



22 Serrated
Lower molars
1424 | \$154.99



73 Serrated
Lower molars
1435 | \$154.99



79 Serrated
Lower Molars
1440 | \$154.99



16 Cowhorn
Lower Molars
1494 | \$154.99



17
Lower Molars
1496 | \$154.99



23 Cowhorn
Lower Molars
1497 | \$154.99



36 Serrated
Lower Premolars
FX36E | \$154.99



210S
Upper Molars
EF11 | \$154.99

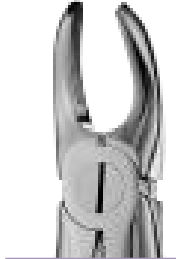

MD2 Mead Serrated
Upper Molars
EF12 | \$154.99



30
Upper Molars
FX30E | \$154.99



34 Special
Upper Incisors & Canines
FX34E | \$154.99



210H
Upper Molars
EF10 | \$154.99



17 Serrated
Upper Molars
1404 | \$154.99



18 Serrated
Upper Molars
1405 | \$154.99



67A Serrated
Upper Molars
1415 | \$154.99



10S
Upper Molars
1475 | \$154.99



18L Harris
Upper Molars
1476 | \$154.99



18R Harris
Upper Molars
1477 | \$154.99



53L
Upper Molars
1481 | \$154.99



53R
Upper Molars
1482 | \$154.99



88L Nevius
Upper Molars
1485 | \$154.99



88R Nevius
Upper Molars
1486 | \$154.99



89 Cook
Upper Molars
EF07 | \$154.99



90 Cook
Upper Molars
EF09 | \$154.99



1S Standard
Upper Incisors & Canines
F1S | \$154.99



16S
Lower Molars
F16S | \$154.99



23S
1st & 2nd Lower Molars
F23S | \$154.99



39
1st & 2nd Lower Molars
F39 | \$154.99



40
Lower Primary Molars
F40 | \$154.99



150XAS Split Beak
Upper Primary Universal
F150XAS | \$154.99



151XAS Split Beak
Lower Primary Molars
F151XAS | \$154.99



150SR Rainbow
Upper Primary Teeth & Roots
F150SR | \$154.99



151SR Rainbow
Lower Primary Teeth & Roots
F151SR | \$154.99



150S Universal
Upper Primary Teeth & Roots
F150S | \$154.99



151S Universal
Lower Primary Teeth & Roots
F151S | \$154.99



1C
Lower incisors
FX1CE | \$154.99



2C
Lower Incisors
FX2CE | \$154.99



3C
Lower roots
FX3CE | \$154.99



4C
Upper premolars
FX4CE | \$154.99



5CE
Upper incisors & canines
FX5CE | \$154.99



6C
Upper molars
FX6CE | \$154.99



7C
Upper Roots
FX7CE | \$154.99



23K Cowhorn
Lower Primary Molars
F23K | \$154.99



150K
Upper Primary Incisors & Roots
F150K | \$154.99



151K
Lower Primary Incisors & Roots
F151K | \$154.99



33 Serrated
Lower Roots
1427 | \$154.99



46L Serrated
Lower roots
1433 | \$154.99



74 Serrated
Lower roots
1436 | \$154.99



74N Serrated
Lower Roots, Narrow Beaks
1437 | \$154.99



86A
Lower Molars
1443 | \$154.99



233 Serrated
Lower Roots
1448 | \$154.99



65
Upper Roots, Fragments & Overlapping Incisors
1483 | \$154.99



69
Upper & Lower Fragments & Roots
1484 | \$154.99



300 Serrated
Upper roots
2530 | \$154.99



301 Serrated
Lower roots
2531 | \$154.99



76S Serrated
Upper roots
2532 | \$154.99



87
Lower Molars
FX87E | \$154.99



49 Serrated
Upper roots
1410 | \$154.99



51 Serrated
Upper roots
1411 | \$154.99



97 Serrated
Upper Roots
1419 | \$154.99



3C Coupland Gouge
E38 | \$109.99

A1C Coupland Gouge
E39 | \$109.99

A2C Coupland Gouge
E40 | \$109.99

A3C Coupland Gouge
E41 | \$109.99

1C Coupland Gouge
E36 | \$109.99



Lindo Levian
1527 | \$109.99



1 Bein, Large
E124 | \$109.99



2 Bein, Medium
E125 | \$109.99



3 Bein, Small
E126 | \$109.99



6 Potts
E42 | Left
E79 | T Bar, Left
E43 | Right
E80 | T Bar, Right

2C Coupland Gouge
E37 | \$109.99



77R Serrated
Serrated
E2 | \$109.99



301 Apexo
E3 | \$109.99



B Cogswell
E4 | \$109.99



21 Cryer
Mini
E5 | \$109.99



22 Cryer
Mini
E6 | \$109.99

34S Seldin
E1 | \$109.99



45 Cryer
Small
E8 | \$109.99



25 Cryer
Medium
E9 | \$109.99



26 Cryer
Medium
E10 | \$109.99



31 Cryer
Large
E11 | \$109.99



32 Cryer
Large
E12 | \$109.99

44 Cryer
Small
E7 | \$109.99



11 Stout
3rd Molars
E45 | \$109.99



11A Stout
3rd Molars
E46 | \$109.99



11M MacMillan Gouge
E47 | \$109.99



A30 Cryer
E13 | \$109.99



A31 Cryer
E14 | \$109.99



1 Heidbrink
E15 | \$109.99



2 Heidbrink
E16 | \$109.99



40 Heidbrink
E17 | \$109.99



41 Heidbrink
E18 | \$109.99



1L Seldin
Upper & Lower Molar
Roots, Left
E19 | \$109.99



1R Seldin
Upper & Lower Molar
Roots, Right
E20 | \$109.99



2S Seldin
Lower 3rd Molars
E21 | \$109.99



3S Seldin
Upper & Lower Anterior
Roots
E22 | \$109.99



34 Seldin
Upper & Lower Anterior
Roots
E23 | \$109.99



4L Seldin
E24 | \$109.99



4R Seldin
E25 | \$109.99



301W Seldin
E26 | \$109.99



304W Seldin
E27 | \$109.99



4 Schmeckebier
E28 | \$109.99



5 Schmeckebier
E29 | \$109.99



71 Miller Apexo
E30 | \$109.99



72 Miller Apexo
E31 | \$109.99



73 Miller Apexo
E32 | \$109.99



74 Miller Apexo
E33 | \$109.99



302 Apexo
E34 | \$109.99



303 Apexo
E35 | \$109.99



8 Crane Pick
E44 | \$109.99



12M MacMillan Gouge
E48 | \$109.99



13M MacMillan Gouge
E49 | \$109.99



15 Woodward
Lower Molar Roots
E50 | \$109.99



16 Woodward
Lower Molar Roots
E51 | \$109.99



19
E52 | \$109.99



20
E53 | \$109.99



23
E54 | \$109.99



31F Friedman Gouge
E55 | \$109.99



32F Fridman Gouge
E56 | \$109.99



38, Serrated
E57 | \$109.99



39, Serrated
E58 | \$109.99



44C Bradley
E59 | \$109.99



46
E60 | \$109.99



46R
E61 | \$109.99



51 Curtis
E62 | \$109.99



52 Curtis
E63 | \$109.99



63 Elevator
E64 | \$109.99



69W Woodward
E65 | \$109.99



77, Serrated
E66 | \$109.99



80
E67 | \$109.99



81
E68 | \$109.99



81A
E69 | \$109.99



81E
E70 | \$109.99



92, Serrated
E71 | \$109.99



93, Serrated
E72 | \$109.99



98
E73 | \$109.99



190
E74 | \$109.99



191
E75 | \$109.99



A Cogswell
E76 | \$109.99



H5 Hourigan
Serrated
E77 | \$109.99



H6 Hourigan
Serrated
E78 | \$109.99



Warwick-James Straight
E81 | \$109.99



Warwick-James Left
E82 | \$109.99



Warwick-James Right
E83 | \$109.99



11LX, Cross-Bar
Handle
E84 | \$109.99



1RX, Cross-Bar
Handle
E85 | \$109.99



11LX, Cross-Bar
Handle
E86 | \$109.99



11RX, Cross-Bar
Handle
E87 | \$109.99



12LX, Cross-Bar
Handle
E88 | \$109.99



12RX, Cross-Bar
Handle
E89 | \$109.99



14LX, Cross-Bar
Handle
E90 | \$109.99



14RX, Cross-Bar
Handle
E91 | \$109.99



Bernard
E114 | Regular |
E115 | Right |
E116 | Left |



Curved, 3 mm
E94 | Regular |
E94S | Serrated |



Straight, 3 mm
E95 | Regular |
E95S | Serrated |



Curved, 2 mm
E92 | Regular |
E92S | Serrated |



Straight, 2 mm
E93 | Regular |
E93S | Serrated |



Curved, 4 mm
E96 | Regular |
E96S | Serrated |



Straight, 4 mm
E97 | Regular |
E97S | Serrated |



Curved, 5 mm
E98 | Regular |
E98S | Serrated |



Straight, 5 mm
E99 | Regular |
E99S | Serrated |



Curved, 2 mm

- EL2CX | Regular | \$134.99
- EL2CXS | Serrated | \$134.99
- SEL2CX | Slim Long | \$134.99
- SSEL2CX | Slim Short | \$134.99



Straight, 2 mm

- EL2SX | Regular | \$134.99
- EL2SXS | Serrated | \$134.99
- SEL2SX | Slim Long | \$134.99
- SSEL2SX | Slim Short | \$134.99



Curved, 3 mm

- EL3CX | Regular | \$134.99
- EL3CXS | Serrated | \$134.99
- SEL3CX | Slim Long | \$134.99
- SSEL3CX | Slim Short | \$134.99



Straight, 3 mm

- EL3SX | Regular | \$134.99
- EL3SXS | Serrated | \$134.99
- SEL3SX | Slim Long | \$134.99
- SSEL3SX | Slim Short | \$134.99



Curved, 4 mm

- EL4CX | Regular | \$134.99
- EL4CXS | Serrated | \$134.99
- SEL4CX | Slim Long | \$134.99
- SSEL4CX | Slim Short | \$134.99



Straight, 4 mm

- EL4SX | Regular | \$134.99
- EL4SXS | Serrated | \$134.99
- SEL4SX | Slim Long | \$134.99
- SSEL4SX | Slim Short | \$134.99



Curved, 5 mm

- EL5CX | Regular | \$134.99
- EL5CXS | Serrated | \$134.99
- SEL5CX | Slim Long | \$134.99
- SSEL5CX | Slim Short | \$134.99



Straight, 5 mm

- EL5SX | Regular | \$134.99
- EL5SXS | Serrated | \$134.99
- SEL5SX | Slim Long | \$134.99
- SSEL5SX | Slim Short | \$134.99



Large, Distal
E100 | \$164.99



Small, Curved
E101 | \$164.99



Small, Straight
E102 | \$164.99



Small, Distal
E103 | \$164.99



Small, Mesial
E104 | \$164.99

Large, Mesial
E105 | \$164.99



Straight Spade
E117 | \$164.99





Angled Right Spade
E120 | \$164.99

Angled Left Spade
E121 | \$164.99

Straight, Large
4.5mm
E122 | \$164.99

Curved, Large
4.5mm
E123 | \$164.99

Mesial Spade
E119 | \$164.99

Distal Spade
E118 | \$164.99



Straight/Curved Standard Splayer Elevator

- S2SSE | Straight, 2MM | \$164.99
- C2SSE | Curved, 2MM | \$164.99
- S4SSE | Straight, 4MM | \$164.99
- C4SSE | Curved, 4MM | \$164.99
- S3SSE | Straight, 3MM | \$164.99
- C3SSE | Curved, 3MM | \$164.99
- S5SSE | Straight, 5MM | \$164.99
- C5SSE | Curved, 5MM | \$164.99

Inverted Tip Splayer Elevator

- IC2SSE | Curved, 2MM | \$164.99
- IC3SSE | Curved, 3MM | \$164.99

Contra Angle Splayer Elevator

- CA2SSE | 2MM | \$164.99
- CA3SSE | 3MM | \$164.99



Iris, Tungsten Carbide

- 05-1484-11 | Straight, Regular | \$52.99
- 05-1485-11 | Curved, Regular | \$52.99
- 05-1842-11C | Siyah, Serrated, Straight | \$149.99
- 05-1843-11C | Siyah, Serrated, Curved | \$149.99
- 05-1842-11 | TC, Straight | \$119.99
- 05-1843-11 | TC, Curved | \$119.99



Dean, Serrated, 18CM

- 200-133 | TC | \$139.99
- 05-1652-17 | Regular | \$74.99



Kelly, Serrated

- 200-131 | TC, Curved, 16CM | \$139.99
- 200-132 | TC, Straight, 16CM | \$139.99
- 05-1454-16 | Regular, Straight, 16CM | \$77.99
- 05-1454-18 | Regular, Straight, 18CM | \$89.99
- 05-1455-16 | Regular, Curved, 16CM | \$77.99
- 05-1455-18 | Regular, Curved, 18CM | \$89.99

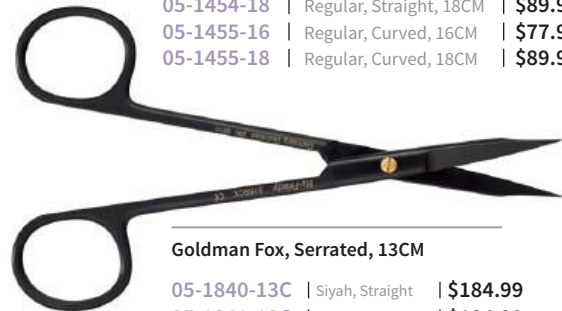

Goldman Fox, Serrated, 13CM

- 05-1840-13C | Siyah, Straight | \$184.99
- 05-1841-13C | Siyah, Curved | \$184.99
- 05-1840-13 | TC, Straight | \$139.99
- 05-1841-13 | TC, Curved | \$139.99
- 05-1645-13 | Regular, Straight | \$69.99
- 05-1646-13 | Regular, Curved | \$69.99



Locklin, Serrated, 16.5 CM

- 200-134 | Curved Shanks | \$139.99
- 200-135 | Straight Shanks | \$139.99



Metzenbaum Blunt

- 05-1773-14C | Siyah, Serrated, Curved, 14CM | \$184.99
- 05-1772-14C | Siyah, Serrated, Straight, 14CM | \$184.99
- 05-1848-18 | Siyah, Serrated, Curved, 18CM | \$194.99
- 05-1868-18 | Siyah, Serrated, Straight, 18CM | \$194.99
- 05-1819-14 | TC, Straight, 14CM | \$134.99
- 05-1825-18 | TC, Straight, 18CM | \$139.99
- 05-1822-14 | TC, Curved, 14CM | \$134.99
- 05-1828-18 | TC, Curved, 18CM | \$124.99



Metzenbaum Delicate

- 05-1820-14 | TC, Straight, 14CM | \$134.99
- 05-1826-18 | TC, Straight, 18CM | \$139.99
- 05-1823-14 | TC, Curved, 14CM | \$134.99
- 05-1829-18 | TC, Curved, 18CM | \$139.99
- 200-136 | TC, Straight Pointed, 14CM | \$134.99
- 200-137 | TC, Curved Pointed, 14CM | \$134.99



LaGrange S Shape, Serrated

- 05-1659-11C | Siyah, 11CM | \$154.99
- 05-1659-15C | Siyah, 15CM | \$169.99
- 05-1659-11 | Regular, 11CM | \$57.99
- 05-1659-15 | Regular, 11CM | \$64.99

Micro Castroviejo Curved

- S31 | 10cm | \$249.99



Castroviejo Scissor

- SPVXC | Siyah, Curved 17CM | \$399.99
- 2517 | TC, Straight, 17CM | \$259.99
- SPVX | Siyah Straight, 17CM | \$399.99

Spencer Stitch

- 05-1601-11 | 11.5 CM Angled | \$54.99
- 05-1598-11 | 11.5 CM Straight | \$54.99
- 05-1598-16 | 16 CM Straight | \$54.99
- 05-1598-09 | 9 CM Straight | \$59.99





TC (Castroviejo) Barraquer Needle Holder

2512	Straight, 18CM	\$349.99
2513	Straight, 16CM	\$399.99
2514	Curved, 16CM	\$349.99
2515	Curved, 18CM	\$399.99
ISCNHS18S	Straight, 18CM, Siyah	\$429.99



Crile Wood

09-2515-15	15 CM with Groove	\$97.99
------------	-------------------	---------



Mayo Hegar

09-2511-16	16 CM	\$97.99
09-2512-14	14 CM	\$97.99



Olsen Hegar

09-2693-14	14 CM	\$164.99
09-2692-11	11 CM	\$164.99
09-2694-17	17 CM	\$164.99



Crile Wood

09-2661-15	15 CM	\$159.99
09-2661-18	18 CM	\$164.99
09-2661-15L	15 CM, Left Handed	\$169.99



Mayo Hegar

09-2652-16	16 CM	\$169.99
09-2652-13	13 CM	\$154.99
09-2511-18	18 CM	\$164.99
09-2653-14	14 CM Curved	\$164.99



Mini Ryder

200-124	15 CM	\$189.99
200-125	18 CM	\$189.99

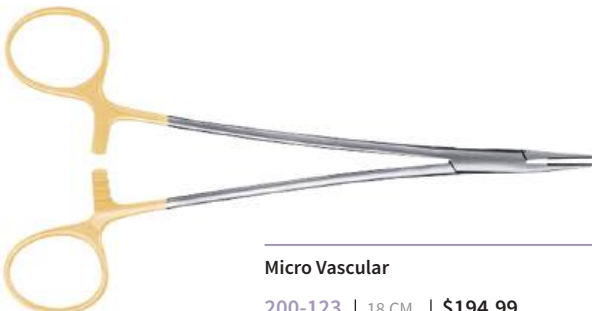

Micro Vascular

200-123	18 CM	\$194.99
---------	-------	----------



Webster, Smooth

09-2648-13	11.5 CM	\$159.99
------------	---------	----------



Hegar Baumgartner
09-2654-14 | 14 CM | \$164.99

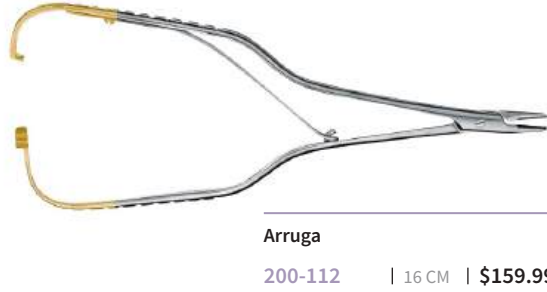

Arruga
200-112 | 16 CM | \$159.99

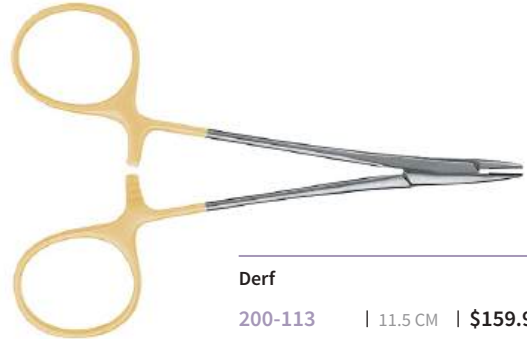

Derf
200-113 | 11.5 CM | \$159.99



Halsey
200-114 | 13 CM | \$159.99
200-116 | 13 CM Smooth | \$159.99



Lichtenberg
200-115 | 20 CM | \$194.99
200-126 | 17 CM | \$194.99



DeBakey, Delicate
200-117 | 18 CM | \$159.99



Fine Swedish Pattern
200-119 | 15 CM | \$174.99

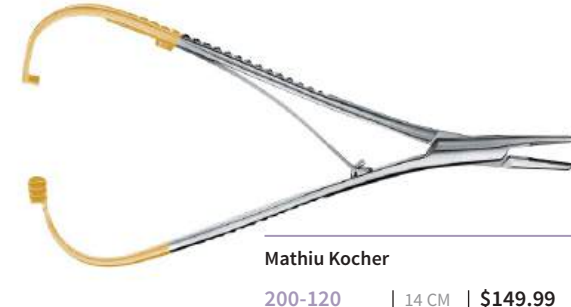

Mathiu Kocher
200-120 | 14 CM | \$149.99



HMT Thin Jaw
200-118 | 15 CM | \$169.99



Mathiu
200-121 | 14 CM | \$149.99



Yankauer

- 1359 | 20 CM | \$99.99
- 1360 | 27 CM | \$99.99

Frazier Suction Tube

- 1362 | 1.5 mm \circ | \$119.99
- 1363 | 2.0 mm \circ | \$119.99
- 1364 | 2.5 mm \circ | \$119.99
- 1365 | 3.0 mm \circ | \$119.99



15CM Mini Friedman Bone Rongeur

- 1599 | Straight | \$184.99
- 1600 | 30° | \$184.99
- 1601 | 45° | \$184.99
- 1602 | 90° | \$184.99



Friedman Bone Rongeur

- 1603 | 30° | \$184.99
- 1604 | 45° | \$184.99



30° Cleveland Side Cutting

- 1614 | 14CM | \$184.99
- 1615 | 17CM | \$184.99



15CM Blumenthal

- 1621 | 30° | \$184.99
- 1622 | 45° | \$184.99
- 1623 | 90° | \$184.99



30° Cleveland Bone Rongeur

- 1612 | 14CM | \$184.99
- 1613 | 17CM | \$184.99



90MM Shaft Kerrison Shortnose

- 1618 | 2MM Tip | \$349.99
- 1619 | 3 MM Tip | \$349.99
- 1620 | 5 MM Tip | \$349.99



15CM Boehler Bone Rongeur

- 1609 | Straight | \$229.99



12CM Mini Friedman Bone Rongeur

- 1605 | 30° | \$184.99



18 CM Weiss Modified
CAL1 | Straight | **\$199.99**
CAL2 | Curved | **\$199.99**



18 CM Standard
CAL3 | Straight | **\$199.99**
CAL4 | Curved | **\$199.99**



11 CM Rounded Castroviejo
CAL5 | Straight | **\$149.99**
CAL6 | Curved | **\$149.99**



18 CM Rounded Castroviejo
CAL7 | Straight | **\$199.99**
CAL8 | Curved | **\$199.99**



16 CM Kelly Rankin Artery Forcep
07-2130-16 | Straight | **\$47.99**
07-2131-16 | Curved | **\$47.99**



12 CM Halstead Mosquito Forcep
07-2113-12 | Straight | **\$44.99**
07-2114-12 | Curved | **\$44.99**



12 CM Halstead Mosquito Forcep
07-2115-12 | Straight | **\$44.99**
07-2116-12 | Curved | **\$44.99**



14 CM Ochsner Kocher Artery Forcep
07-2156-14 | Straight | **\$47.99**
07-2157-14 | Curved | **\$47.99**



16 CM Rochester Pean Fine Artery Forcep
07-2154-16 | Straight | **\$47.99**
07-2155-16 | Curved | **\$47.99**



18 CM Adson Artery Forcep
07-2177-18 | Straight | **\$54.99**
07-2178-18 | Curved | **\$54.99**



Kelly Artery Forcep, Half Serrated
07-2128-14 | 14 CM Straight | **\$47.99**
07-2129-14 | 14 CM Curved | **\$47.99**



Allis Tissue

26-13502-15 | 15CM, 5x6 Teeth | \$64.99



Adson Forcep, 12 CM

06-2033-12 | Dressing, Serrated, TC | \$144.99
 06-2044-12 | 1x2, Serrated, TC | \$144.99
 06-1919-12 | Dressing, Serrated | \$62.99
 06-1981-12 | Tissue 1x2 Teeth | \$62.99



Adson Brown, 12CM

06-2045-12 | 3x4 Teeth TC | \$144.99
 06-1984-12-6 | 3x4 Teeth | \$62.99

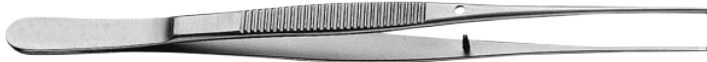

Semken, 12.5 CM

06-1964-12 | 1x2 Teeth, Straight | \$62.99
 06-1965-12 | 1x2 Teeth Curved | \$62.99
 06-1921-12 | Serrated, Straight | \$62.99
 06-1922-12 | Serrated, Curved | \$62.99



Gerald, 18CM

200-105 | Serrated, TC | \$149.99
 200-106 | 1x2 Teeth, Serrated, TC | \$149.99
 06-1970-18 | 1x2 Teeth, Straight | \$69.99
 06-2047-18 | 1x2 Teeth, Curved | \$69.99
 06-1923-18 | Serrated, Straight | \$69.99
 06-1924-18 | Serrated, Curved | \$69.99



20 Corn Suture Plier

200-110 | 15 CM | \$69.99
 200-111 | Micro | \$134.99

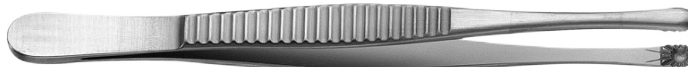

Russian Tissue Forcep

200-108 | 15 CM | \$69.99
 200-109 | 20 CM | \$74.99



Fox Tissue, 3x3 Teeth

TP50 | 15 CM | \$69.99
 TP50L | 15 CM, Locking | \$74.99



Debakey Atraumatic, 2.0 MM

14-4109-16 | 15 CM | \$154.99
 14-4109-20 | 20 CM | \$164.99



Potts Smith, Serrated

06-2041-18 | 18 CM | \$154.99
 06-2041-20 | 20 CM | \$159.99



Cushing Dressing, Tungsten Carbide

06-2038-18 | 16.5 CM, Bayonet | \$154.99
 06-2037-18 | 18 CM, Angled | \$154.99
 200-107 | 18CM, | \$154.99

1 Woodson	2268	\$99.99
#1 Kramer Nevins	2271	\$99.99
#152 Kramer Nevins	2272	\$99.99
Buser	2275	\$99.99
Allen Anterior	2276	\$99.99
Allen	2277	\$99.99
9 Molt	1633	\$99.99
9 Molt Perforated	1634	\$99.99
This product is 4.3 mm on one side & 8.4 mm on other		
16 Freer Strongly Curved	2348	\$99.99
1 Hopkins	1635	\$99.99
2 Hopkins	1636	\$99.99
3 Mead	1637	\$99.99
12S Bennett	1639	\$99.99
14 Goldman Fox	1640	\$99.99
23 Seldin	1641	\$99.99



152 Kramer Nevins 2272S \$119.99

24G 1642S \$119.99



14 Goldman Fox 1640S \$119.99

	P9/PA6	2258	\$99.99
	8D	2259	\$99.99
	9H Howard	2260	\$99.99
	15 Freer Curved	2262	\$99.99
	20 Hirschfield	2263	\$99.99
	#149	2265	\$99.99
	Benque	2266	\$99.99
	24G	1642	\$99.99
	3 Prichard	1643	\$99.99
	3/9A	1644	\$99.99
	9A Allen	2349	\$99.99
	9 Molt	1633S	\$119.99
	3 Prichard	1643S	\$119.99
	Allen	2277S	\$119.99
	Buser	2275S	\$119.99
	1 Woodson	2268S	\$119.99
	Allen Anterior	2276S	\$119.99
	Allen Posterior PPAELPX	\$119.99	

1 Posterior

- 2337 | Regular | \$99.99
- PT1S | Siyah | \$119.99
- PT1SS | Serrated | \$119.99



2 Anterior

- 2338 | Regular | \$99.99
- PT2S | Siyah | \$119.99
- PT2SS | Serrated | \$119.99



3 Posterior Right

- 2339 | Regular | \$99.99
- PT3S | Siyah | \$119.99
- PT3SS | Serrated | \$119.99



4 Posterior Left

- 2340 | Regular | \$99.99
- PT4S | Siyah | \$119.99
- PT4SS | Serrated | \$119.99



5 Anterior Angled

- 2341 | Regular | \$99.99
- PT5S | Siyah | \$119.99
- PT5SS | Serrated | \$119.99



6 Anterior Straight

- 2342 | Regular | \$99.99
- PT6S | Siyah | \$119.99
- PT6SS | Serrated | \$119.99



1 Root Tip Pick

- 1587 | Heidbrink | \$99.99
- 2245 | Howard | \$99.99



2 Root Tip Pick, Angled Left

- 1588 | Heidbrink | \$99.99
- 2246 | Howard | \$99.99



3 Root Tip Pick, Angled Right

- 1589 | Heidbrink | \$99.99
- 2247 | Howard | \$99.99



4 Root Tip Pick, Curved Up

- 2239 | Heidbrink | \$99.99
- 2248 | Howard | \$99.99



5 Root Tip Pick, Curved Down

- 2240 | Heidbrink | \$99.99
- 2249 | Howard | \$99.99



Root Tip Pick, Double End

- 2241 | 13/14 Heidbrink | \$99.99
- 2250 | 2/3 Howard | \$99.99
- 2241S | Siyah, Heidbrink | \$119.99
- 2250S | Siyah, Howard | \$119.99





1 Austin Retractor

200-103 Left | \$99.99
200-104 Right | \$99.99



Bishop Cheek Retractor
1366 | 13 CM | \$59.99



University of Minnesota Cheek Retractor
1367 | 14 CM | \$54.99



Cawood Minnesota
1368 | 16 CM | \$59.99



Columbia Cheek Retractor
1369 | 14 CM | \$54.99



Farabeuf, Set of 2
200-101 | \$89.99



Orringer, Hands Free
CROS Small | \$64.99
CROM Medium | \$64.99
CROL Large | \$64.99



Molt Mouth Gag

1381 | Large | \$149.99
1382 | Medium | \$149.99
1383 | Small | \$149.99

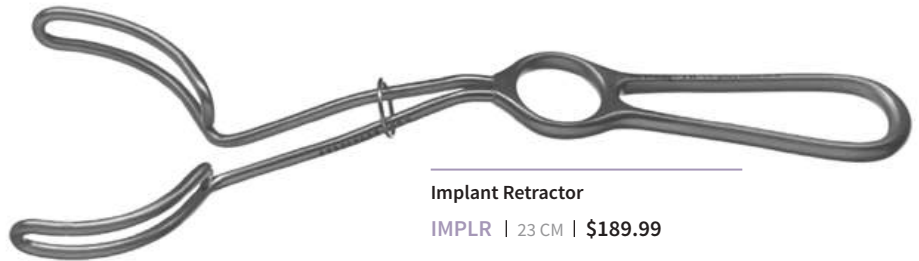

Implant Retractor
IMPLR | 23 CM | \$189.99

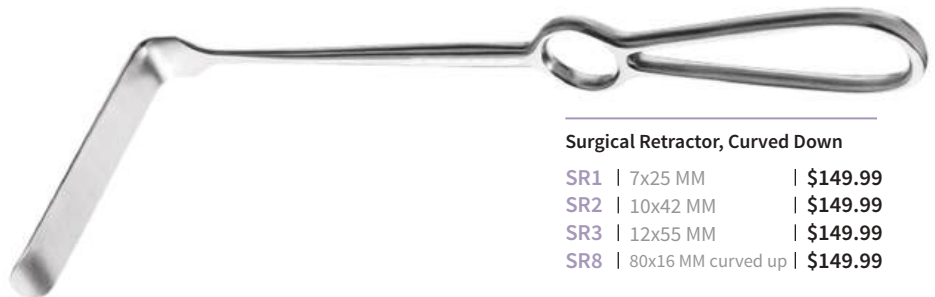

Surgical Retractor, Curved Down

SR1 | 7x25 MM | \$149.99
SR2 | 10x42 MM | \$149.99
SR3 | 12x55 MM | \$149.99
SR8 | 80x16 MM curved up | \$149.99



Henahan

- 1370 | 10 MM | \$94.99
- 1371 | 12 MM | \$94.99
- 1372 | 15 MM | \$94.99

Weider Tongue Retractor

- 1374 | Small | \$99.99
- 1375 | Large | \$99.99



Desmarres Chalazion

- 17-7838-01 | Small, 17x11mm | \$87.99
- 17-7838-02 | Medium, 23x12mm | \$87.99



Channel Retractor

- 21-11194-08 | 16cm | \$99.99



Ramus Retractor, V Notch, Curved Down

- SR9 | 70 x 11 mm | \$149.99



Middeldorpf Retractor

- MIDLS | 17 x 14 mm | \$149.99
- MIDL M | 22 x 20 mm | \$149.99

#3 Scalpel Handle

- 1385 | \$27.99
- 1384 | \$24.99



PUSH Scalpel Handle

- AS9217 | \$149.99



#5 Round Scalpel Handles

- 1389 | Straight | \$54.99
- 1390 | Curved | \$59.99
- 1391 | Double Blade | \$99.99



SURGICAL

1X Miller Colburn 2282 \$109.99

The 1X Miller-Colburn cross-cut bone file is used for final smoothing & shaping of bone with 8.1 mm & 4.8 mm wide working ends



2X Miller Colburn 2283 \$109.99

The 2X Miller-Colburn cross-cut bone file is used for final smoothing & shaping of bone with 6.2 mm wide working ends



3X Miller Colburn 2284 \$109.99

The 3X Miller-Colburn cross-cut bone file is used for final smoothing & shaping of bone with 6.2 mm & 4.8 mm working ends



12A Miller 1653 \$109.99

The 3X Miller-Colburn cross-cut bone file is used for final smoothing & shaping of bone with 6.2 mm & 4.8 mm working ends



21 Miller 2280 \$109.99

8.1 mm & 4.8 mm working ends



67 Howard 1649 \$109.99

with 4.8mm wide, angled working ends



45 Miller 1650 \$109.99

The 45 Miller straight-cut bone file used for final smoothing & shaping of bone with 6.2mm wide working ends



52 Miller 1651 \$109.99

The 67 Miller straight-cut bone file used for final smoothing & shaping of bone with 4.8mm wide, angled working ends



12 Howard 1652 \$109.99

The 12 Howard straight-cut bone file is used for final smoothing & shaping of bone with 8.1mm wide working ends



64 Miller 1654 \$109.99

The 64 Miller straight-cut bone file used for final smoothing & shaping of bone with 6.2 mm & 4.8mm wide working ends



1 Wahl 1655 \$109.99

The 1W Wahl straight-cut bone file is used for final smoothing & shaping of bone with 8.1mm wide working ends



2 Wahl 1656 \$109.99

The 64 Miller straight-cut bone file used for final smoothing & shaping of bone with 6.2 mm & 4.8mm wide working ends





84 Lucas, 2MM

- 1624 | Regular | \$89.99
- 1624S | Siyah | \$119.99
- 1624SS | Serrated | \$119.99

85 Lucas, 2.5MM

- 1625 | Regular | \$89.99
- 1625S | Siyah | \$119.99
- 1625SS | Serrated | \$119.99

86 Lucas, 2.8MM

- 1626 | Regular | \$89.99
- 1626S | Siyah | \$119.99
- 1626SS | Serrated | \$119.99

87 Lucas, 3.5 MM

- 1627 | Regular | \$89.99
- 1627S | Siyah | \$119.99
- 1627SS | Serrated | \$119.99

88 Lucas, 4.7MM

- 1628 | Regular | \$89.99
- 1628S | Siyah | \$119.99
- 1628SS | Serrated | \$119.99

2/4 Molt, 3.5/7 MM

- 2251 | Regular | \$89.99
- 2251S | Siyah | \$119.99

1/2 Siyah Buser Modified 2173S \$119.99

4 mm/5 mm

2/3 Siyah Buser Modified 2174S \$119.99

5 mm/6 mm

1/3 Siyah Buser Modified 2175S \$119.99

4 mm/6 mm

1 Fedi

1259 | \$84.99

36/37 Rhodes

1258 | \$84.99

1 Ochsenbein

1253 | \$94.99

2 Ochsenbein

1254 | \$94.99

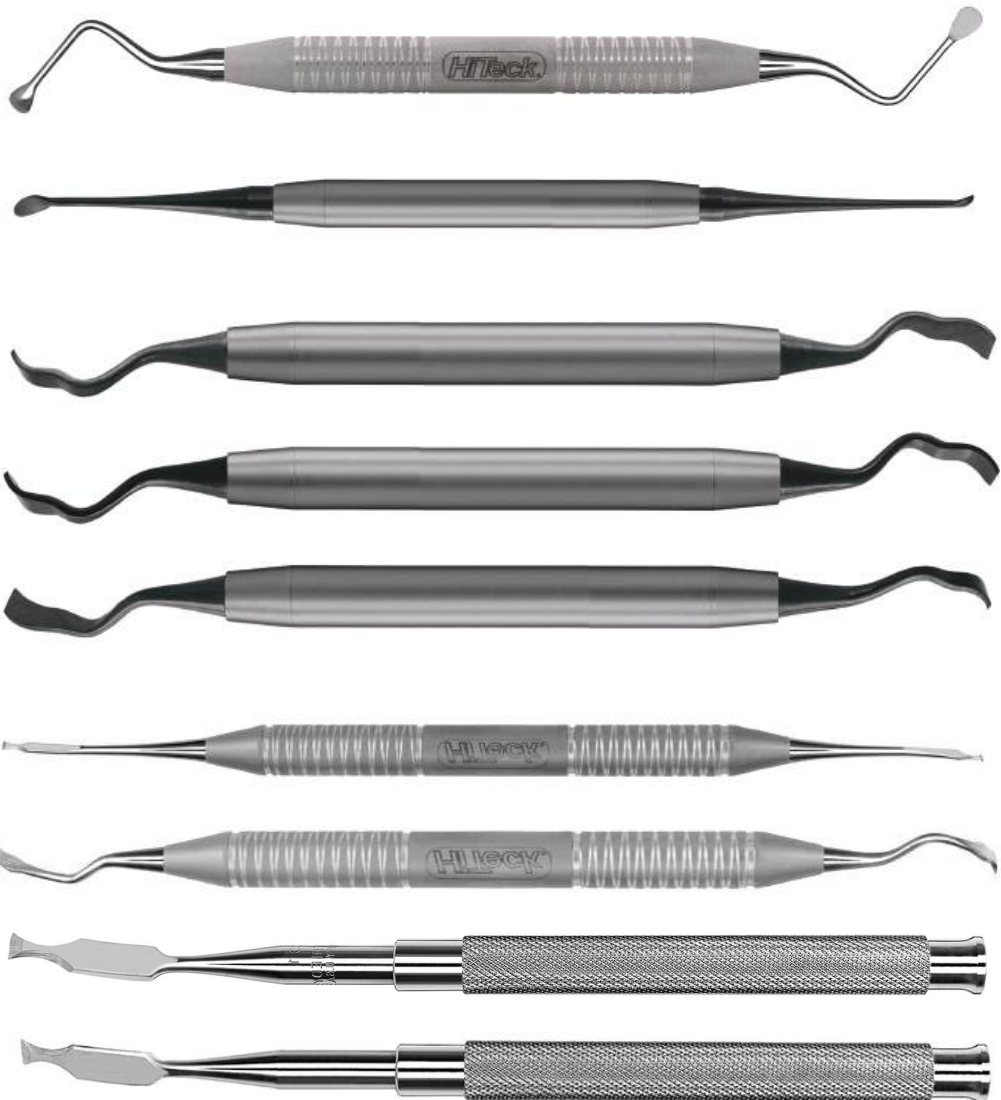

	#1 Siyah Tunneling	TKN1	\$119.99
	#2 Siyah Tunneling	TKN2	\$119.99
	1/2 Siyah Orban	2168S	\$119.99
	15/16 Siyah Kirkland	1241S	\$119.99
	11 Siyah Goldman Fox	1246S	\$119.99
	Allen End Cutting Siyah Intraculular Knife	SPKA	\$119.99
	Siyah Allen Arrow-head Knife	AAHK	\$119.99
	3/4 Buck	1247	\$84.99
	5/6 Buck	1248	\$84.99
	7 Goldman Fox	1242	\$84.99
	8 Goldman Fox	1243	\$84.99

	1/2 Siyah Allen Modified Orban Knife	AMOK1/2	\$109.99
---	--------------------------------------	---------	----------



Concave Bone Pushing Osteotome, Straight 8-10-13-15-17,20 MM Markings

BPOTCT27	2.7MM	\$149.99
BPOTCT32	3.2MM	\$149.99
BPOTCT37	3.7MM	\$149.99
BPOTCT42	4.2MM	\$149.99
BPOTCT50	5.0MM	\$149.99

Convex Bone Pushing Osteotome, Straight 8-10-13-15-17,20 MM Markings

BPOTCVT27	2.7MM	\$149.99
BPOTCVT32	3.2MM	\$149.99
BPOTCVT37	3.7MM	\$149.99
BPOTCVT42	4.2MM	\$149.99
BPOTCVT50	5.0MM	\$149.99

Convex Bone Pushing Osteotome, Angled 8-10-13-15-17,20 MM Markings

BPOTCVT27A	2.7MM	\$149.99
BPOTCVT32A	3.2MM	\$149.99
BPOTCVT37A	3.7MM	\$149.99
BPOTCVT42A	4.2MM	\$149.99
BPOTCVT50A	5.0MM	\$149.99

Concave Bone Pushing Osteotome, Angled 8-10-13-15-17,20 MM Markings

BPOTCT27A	2.7MM	\$149.99
BPOTCT32A	3.2MM	\$149.99
BPOTCT37A	3.7MM	\$149.99
BPOTCT42A	4.2MM	\$149.99
BPOTCT50A	5.0MM	\$149.99



Flat Osteotome, 7-10-13-15-18 MM Markings

2303	4 MM, Straight	\$99.99
2304	4 MM, Curved	\$99.99
2305	7.5 MM, Straight	\$99.99
2306	7.5 MM, Curved	\$99.99

Round Osteotome, 7-8-13-15-18 MM Markings

2308	#1, 2.7 MM	\$129.99
2309	#2, 3.2 MM	\$129.99
2310	#3, 3.7 MM	\$129.99
2311	#4, 4.2 MM	\$129.99



Ridge Split Chisel #4
RSC4 | 4 MM, Straight | \$189.99



Ridge Split Chisel #3
RSC3 | 3 MM, Straight | \$189.99



Ridge Split Chisel #2
RSC2 | 2 MM, Straight | \$189.99



Ridge Split Chisel #1
RSC1 | 1 MM, Straight | \$189.99

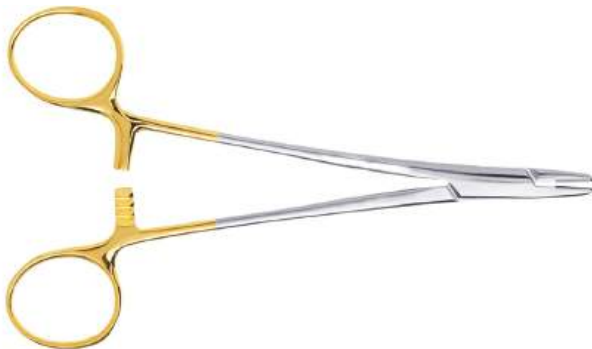

Wire Twister, TC Tips 13-3892-18 \$179.99

18 CM

Wire Twister, TC Tips 13-3892-16 \$179.99

16 CM

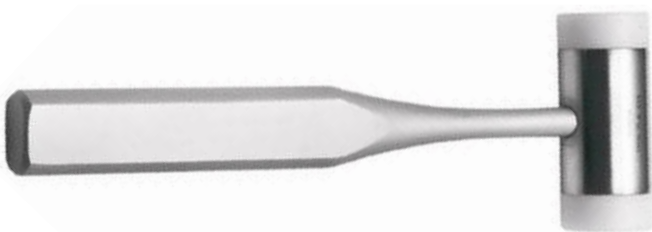

#1 Mead Mallet

MAL1 | \$109.99

Reliable, high-quality diagnostic instruments are essential for accuracy and efficiency in every procedural setup. Our selection includes color-coated steel probes, Lachak Explorers, and HD & Black Line Mirrors, all designed for enhanced visibility, precision, and durability. These instruments provide clinicians with the tools they need for optimal diagnosis, treatment planning, and patient care, ensuring long-lasting performance in daily practice.

EXPROS

An Expro is excellent for dental examinations and charting, since it combines two critical instruments required for every effective diagnostic setup – an explorer on one end and a probe on the other.

EXPLORERS

Explorers are crafted from Lachak Steel, a specially blended steel alloy which provides flexibility and resilience for precise diagnostic procedures.

DIAGNOSTIC

PROBES

Colour Probes are coded with accurate, smooth black markings, which will not chip, flake, or fade. Colour Probes feature a vivid markings for enhanced contrast intraorally.

HD MIRRORS

Designed for enhanced performance, our HD Siyah Line Mirrors are engineered to optimize clinical outcomes by delivering superior visibility throughout any dental procedure. The Diamond Like Carbon (DLC) coating of the handle and the mirror frame reduces glare up to 80%! The durable black matte finish in combination with the superior brilliance and color of our proprietary HD Mirror glass facilitates quicker and more accurate visibility of the mouth.

TWEEZERS

Used to grasp or transfer materials in and out of the oral cavity, all dressing pliers are made of heavy gauge, heat-treated stainless steel to ensure long life and precise beak alignment.

HOW TO READ A PROBE

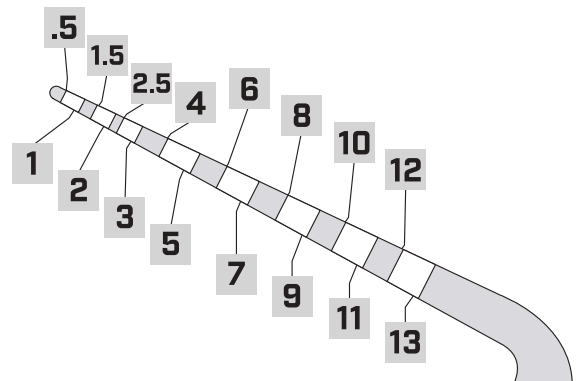



College 1157 \$27.99



Meriam 1158 \$27.99



College, Locking 1160 \$32.99



Perry 1162 \$27.99
4mm



Signature Mirror Handle 1168 \$28.99



Signature Mirror Handle, Siyah 1168S \$34.99



#4 Mirrors, Cone
22MM, Pack of 12
1169 | \$47.99



#5 Mirrors, Cone
24MM, Pack of 12
1170 | \$47.99



#4 Double Sided
Mirrors, Cone
22MM
1171 | \$47.99



#5 Double Sided
Mirrors, Cone
24MM
1172 | \$47.99



#5 Mirror, Cone, Siyah
22MM
SMC5 | \$17.99



#5 Double Mirror,
Cone, Siyah
24MM
SMDC5 | \$17.99

2 Siyah Explorer **1112s** \$49.99



3CH Siyah Cow-horn Explorer **1114s** \$49.99



5 Siyah Explorer **1115s** \$49.99



TU17/23 Siyah Explorer **1116s** \$49.99



23/CP 12 Siyah Expro **1150s** \$49.99



ODU 11/12 Siyah Explorer **1122s** \$49.99



1 Explorer **1111** \$39.99



2 Explorer **1112** \$39.99



2A Pigtail Explorer **2210** \$39.99



2H Explorer **2211** \$39.99



2R/2L Explorer **2212** \$39.99



3ES Explorer **2213** \$39.99



3 Explorer **1113** \$39.99



3CH Explorer **1114** \$39.99



5 (17/23) Explorer **1115** \$39.99



DIAGNOSTIC

TU17/23 Explorer 1116 \$39.99

6/3 Explorer 1117 \$39.99

23/6 Explorer 1118 \$39.99

ODU 11/12 Explorer 1122 \$39.99

ODU 11/12 Elongated Explorer 1122AF \$39.99

23/QW Williams 1146 \$39.99

[1-2-3-5-7-8-9-10]

23/CP8 Expro 1147 \$39.99

[3-6-8-11]

23/CP11 Expro 1148 \$39.99

[3-6-8-11]

23/CP11.5Ball Expro 1149 \$39.99

[3.5-5.5-8.5-11 Ball]

23/CP12 Expro 1150 \$39.99

[3-6-9-12]

23/UNC15 Expro 1151 \$39.99

[1-2-3-4-5-6-7-8-9-10-11-12-13-14-15]

23/UNC12 Expro 2223 \$39.99

[1-2-3-4-5-6-7-8-9-10-11-12]

CPNT3/CP12 Expro 2224 \$39.99

[1-2-3-5-7-8-9-10]

TU17/UNC15 Expro 1152 \$39.99

[1-2-3-4-5-6-7-8-9-10-11-12-13-14-15]

6/QW Williams Expro 1153 \$39.99

3A/UNC15 1154 \$39.99

23/Goldman Fox 1155 \$39.99

23/O Michigan 1156 \$39.99

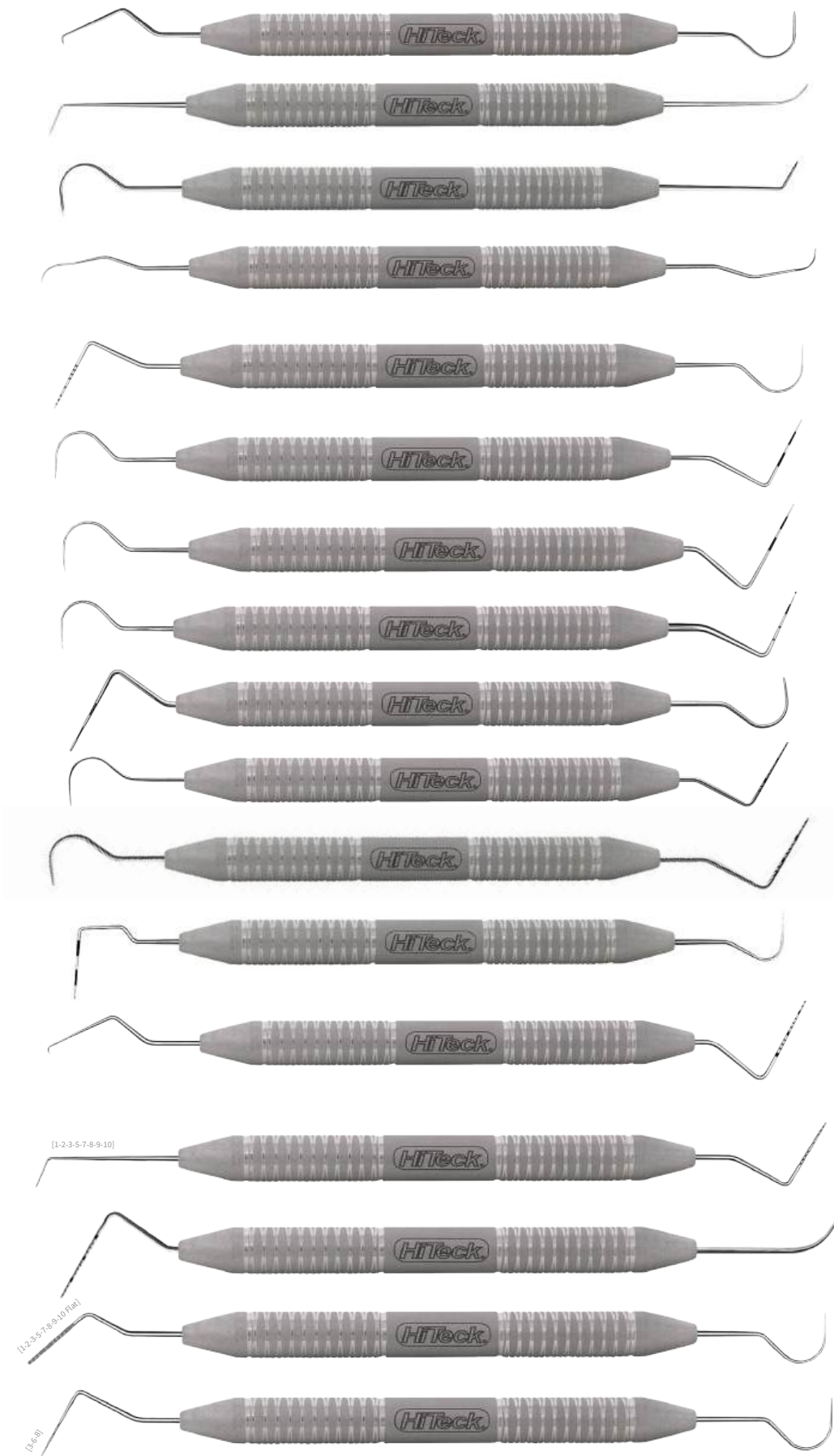

[1-2-3-5-7-8-9-10]

[1-2-3-5-7-8-9-10 Flat]

[6-8-9]

CP 2	1123	\$39.99
CP 8	1124	\$39.99
CP 10	1125	\$39.99
CP 11	1126	\$39.99
CP 12	1127	\$39.99
CP 15 UNC	1128	\$39.99
PQ Williams	1130	\$39.99
CP 11.5 Ball	1131	\$39.99
Goldman Fox	1134	\$39.99
UNC15/11.5B Probe	1137	\$39.99
CP12/11.5B Probe	1138	\$39.99
PQW/11.5B Probe	1139	\$39.99
2N Nabers Probe	1141	\$39.99
Q2N Nabers Probe	1142	\$39.99
GF/Williams Probe	1143	\$39.99
CP12/Williams Probe	1144	\$39.99
UT3/4 Cattoni Probe	1145	\$39.99
Williams Williams Offset Probe	2410	\$39.99

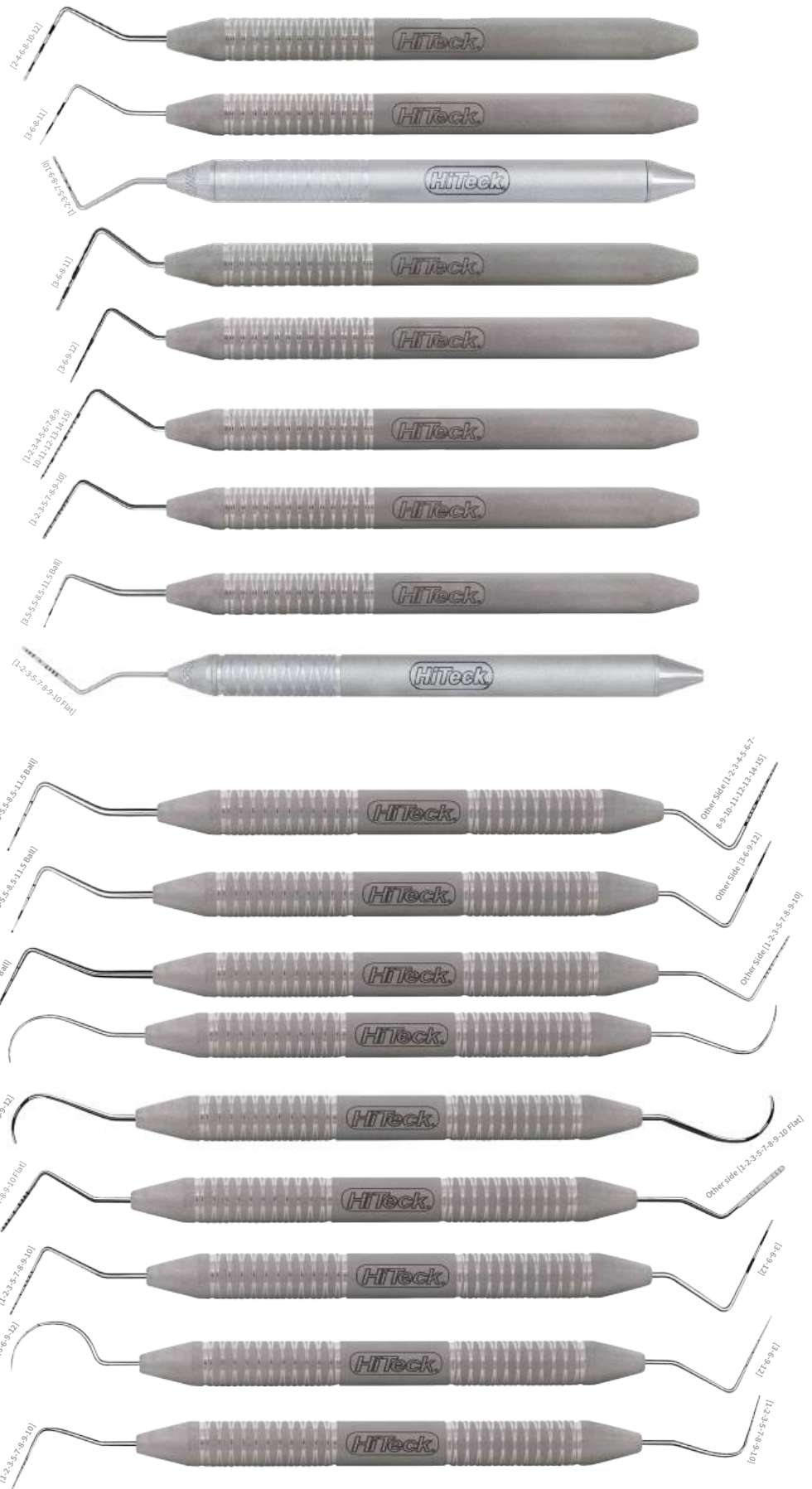

Our hand scalers are precision-crafted from high-grade stainless steel for exceptional durability and performance. Designed for sharpness and long-lasting edge retention, they provide reliable efficiency in every procedure. With meticulous craftsmanship, these instruments ensure precise handling, enhancing patient care with ease.

GRACEY COMPARISON CHART

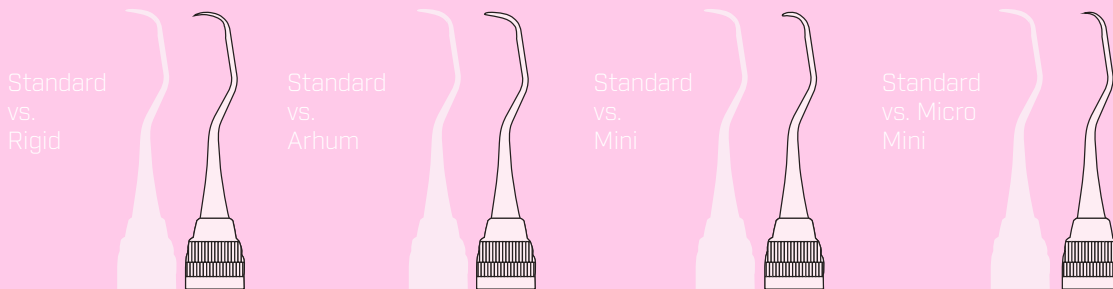

GRACEY CURETTE BLADE ANGULATION

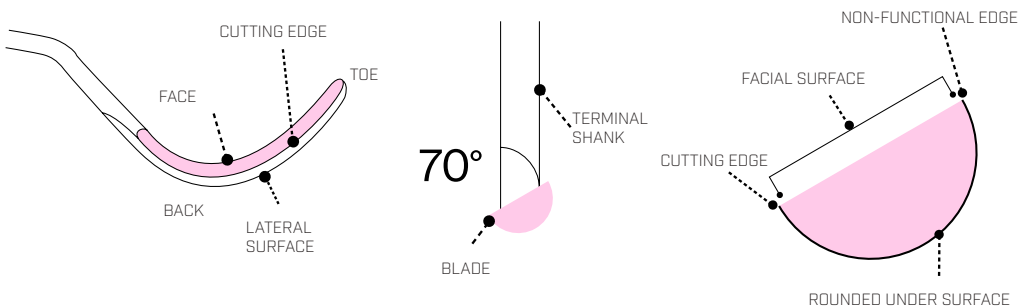

ARHUM Gracey Curettes

Designed to adapt to a specific area or tooth surface.

- Longer terminal shank allows better access to deep pockets and areas with recession.
- Blade is 10% thinner than standard Gracey curette to allow for less tissue distention when accessing deeper pockets.

ARHUM GRACEY

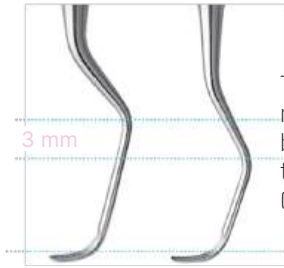

Terminal shank redesigned to be 3 mm longer than a standard Gracey curette.

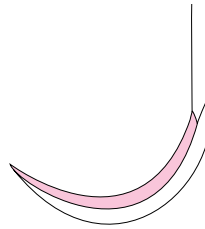

The Curved Sickle Scaler

Two cutting edges on a curved blade that end in a sharp point

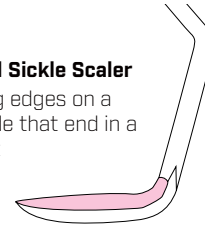

The Straight Sickle Scaler

Two cutting edges on a straight blade that end in a sharp point (also known as a Jacquette Scaler)

DESIGN COMPARISONS

Gracey Type	Shank Design & Diameter	Blade Length	Blade Width	Available Patterns & Area of Use
Standard	Standard	Standard	Standard	1/2, 3/4, 5/6 7/8, 9/10 11/12, 15/16 13/14, 17/18*
Rigid	Standard design, increased shank diameter	Standard	Standard	1/2, 3/4, 5/6 7/8, 9/10 11/12, 15/16 13/14, 17/18*
ARHUM	Longer terminal shank, standard diameter	Standard	Decreased by 10% compared to Standard	1/2, 3/4, 5/6 7/8 11/12, 15/16 13/14
Rigid ARHUM	Longer terminal shank, increased diameter	Standard	Decreased by 10% compared to Standard	1/2, 3/4, 5/6 7/8 11/12, 15/16 13/14
Mini	Longer terminal shank, standard diameter	Decreased by 50%	Decreased by 10% compared to Standard	1/2, 3/4, 5/6 7/8 11/12, 15/16 13/14
Rigid Mini	Longer terminal shank, standard diameter	Decreased by 50%	Decreased by 10% compared to Standard	1/2, 3/4, 5/6 7/8 11/12, 15/16 13/14
Micro Mini	Longer terminal shank, standard diameter	Decreased by 50%	Decreased by 20% compared to Mini Five	1/2 7/8 11/12 13/14

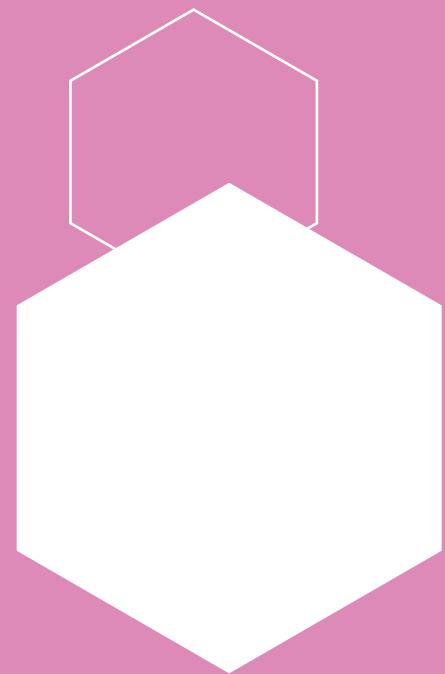

Anterior	1/2, 3/4, 5/6
Buccal/Lingual	7/8, 9/10
Mesial Surfaces Premolars, Molars	11/12, 15/16
Distal Surfaces Premolars, Molars	13/14, 17/18*

H6/H7 Hygienist 1175 \$44.99



H5/J33 Jacquette 1176 \$44.99



H5/U15 Hygienist 2101 \$44.99



6/7 Goldman 2102 \$44.99
Shortened version of the H6/H7 Scaler.



U15/J30 Towner Jacquette 1177 \$44.99



U15/J33 Towner Jacquette 1178 \$44.99



204 Sickle 1183 \$44.99



204 IUFW 2105 \$44.99



204S Scaler 1184 \$44.99



204SD Scaler 1185 \$44.99
Posterior



3/4 Remington 2109 \$44.99
Distal



137 Anterior Sickle 2111 \$44.99
Anterior Sickle/Anterior Universal Curette Combo.



135 Sickle 1187 \$44.99



30/33 Jacquette 1180 \$44.99
Standard/Miniature Anterior Jacquette.



31/32 Jacquette 1181 \$44.99
Posterior standard jacquette



34/35 Jacquette 1182 \$44.99
Scaler
Posterior miniature Jacquette



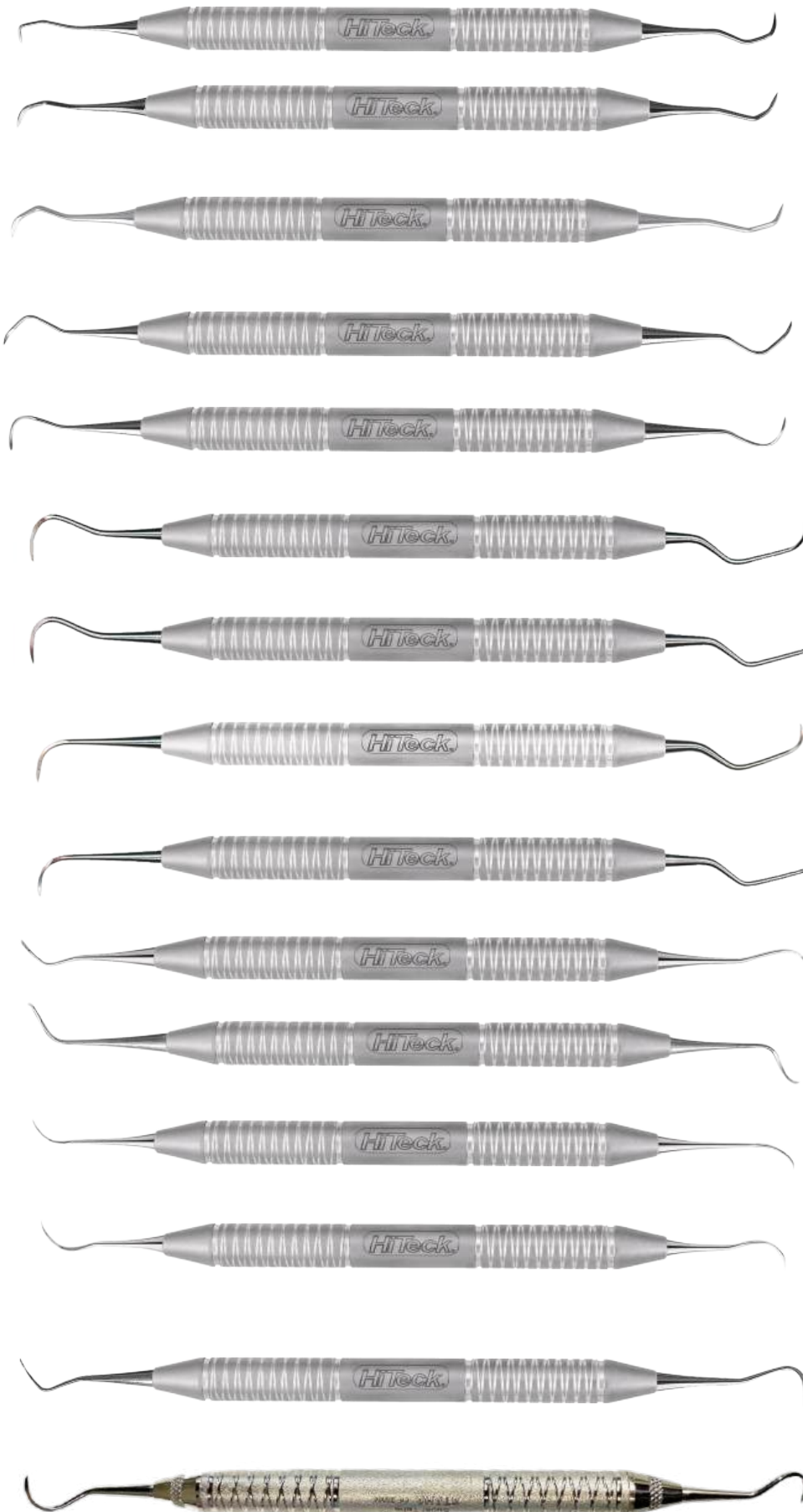

H3/H4 Jacquette	2103	\$44.99
14/15 Posterior Jacquette	2104	\$44.99
McCall 11/12	1191	\$44.99
13S/14S McCall	1192	\$44.99
17S/18S McCall	1195	\$44.99
H5 Langer 5	H5L5	\$44.99
2-in-1 anterior instrument with an H5 straight sickle scaler on one end for deposit removal and interproximal access		
H5 Langer 5 Mini	H5L5M	\$44.99
Features a mini Langer version of the H5-L5		
Nebraska 128/ Langer 5	N128L5	\$44.99
2 in 1 anterior instrument with a Nebraska 128 on one end for narrow, interproximal access		
Nebraska 128 Langer 5 Mini	N128L5M	\$44.99
TAHA 1 Anterior	TAHA1	\$44.99
Similar to NEVI 1		
TAHA 2 Posterior	TAHA2	\$44.99
Similar to NEVI 2.		
TAHA 3 Posterior	TAHA3	\$44.99
Similar to NEVI 3		
TAHA 4 Posterior	TAHA4	\$44.99
	TAHA4S	\$44.99
Similar to NEVI 4.		
Taha 1/H5 Anterior	TAHA1H5	\$44.99
Similar to NEVI1H5.		
Super Taha (Montana Jack)	STAHA	\$44.99
Equivalent to R138 (Montana Jack) scaler.		

1/2 Langer **1204** **\$44.99**

For mandibular posterior



3/4 Langer **1205** **\$44.99**



5/6 Langer **1206** **\$44.99**



17/18 Langer **1207** **\$44.99**



13/14 Indiana **1208** **\$44.99**

Anterior



17/18 Indiana **1209** **\$44.99**

Posterior



7/8 Younger Good **1212** **\$44.99**



1/2 Barnhart **1213** **\$44.99**



5/6 Barnhart **1214** **\$44.99**



2R/2L Columbia **1215** **\$44.99**



4R/4L Columbia **1216** **\$44.99**

Posterior application



13/14 Columbia **1217** **\$44.99**

Universal application



3/4 Rule **1218** **\$44.99**





1/2	1229	\$44.99
1/2 Mini	1220	\$44.99
1/2 Rigid	G12R	\$44.99
1/2 Mini Rigid	G12MR	\$44.99
1/2 Micro Mini	1/2MMG	\$44.99
1/2 Arhum	AG12	\$44.99
1/2 Arhum Rigid	AG12R	\$44.99



3/4	1230	\$44.99
3/4 Mini	1221	\$44.99
3/4 Rigid	G34R	\$44.99
3/4 Mini Rigid	G34MR	\$44.99
3/4 Arhum	AG34	\$44.99
3/4 Arhum Rigid	AG34R	\$44.99



5/6	1231	\$44.99
5/6 Mini	1222	\$44.99
5/6 Rigid	G56R	\$44.99
5/6 Mini Rigid	G56MR	\$44.99
5/6 Arhum	AG56	\$44.99
5/6 Arhum Rigid	AG56R	\$44.99



7/8	1232	\$44.99
7/8 Mini	1223	\$44.99
7/8 Rigid	G78R	\$44.99
7/8 Mini Rigid	G78MR	\$44.99
7/8 Micro Mini	7/8MMG	\$44.99
7/8 Arhum	G78	\$44.99
7/8 Arhum Rigid	AG78R	\$44.99



9/10	1233	\$44.99
9/10 Mini	1224	\$44.99
9/10 Rigid	G910R	\$44.99
9/10 Mini Rigid	G910MR	\$44.99



11/12	1234	\$44.99
11/12 Mini	1225	\$44.99
11/12 Rigid	G1112R	\$44.99
11/12 Mini Rigid	G1112MR	\$44.99
11/12 Micro Mini	11/12MMG	\$44.99
11/12 Arhum	AG1112	\$44.99
11/12 Arhum Rigid	AG1112R	\$44.99



13/14	1235	\$44.99
13/14 Mini	1226	\$44.99
13/14 Rigid	G1314R	\$44.99
13/14 Mini Rigid	G1314MR	\$44.99
13/14 Micro Mini	13/14MMG	\$44.99
13/14 Arhum	AG1314	\$44.99
13/14 Arhum Rigid	AG1314R	\$44.99



15/16	1236	\$44.99
15/16 Mini	1227	\$44.99
15/16 Rigid	G1516R	\$44.99
15/16 Mini Rigid	G1516MR	\$44.99
15/16 Arhum	AG1516	\$44.99
15/16 Arhum Rigid	AG1516R	\$44.99















17/18	1237	\$44.99
17/18 Mini	1228	\$44.99
17/18 Rigid	G1718R	\$44.99
17/18 Mini Rigid	G1718MR	\$44.99
17/18 Arhum	AG1718	\$44.99
17/18 Arhum Rigid	AG1718R	\$44.99

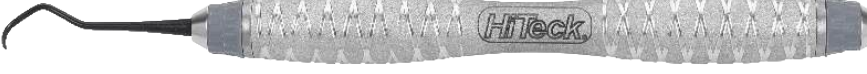
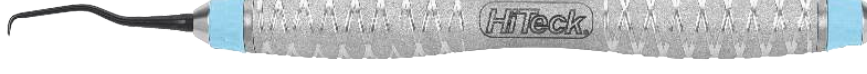

11/14	2143	\$44.99
11/14 Mini	G1114M	\$44.99
11/14 Rigid	G1114R	\$44.99
11/14 Mini Rigid	G1114MR	\$44.99
11/14 Arhum	AG1114	\$44.99
11/14 Arhum Rigid	AG1114R	\$44.99



12/13	2144	\$44.99
12/13 Mini	G1213M	\$44.99
12/13 Rigid	G1213R	\$44.99
12/13 Mini Rigid	G1213MR	\$44.99
12/13 Arhum	AG1213	\$44.99
12/13 Arhum Rigid	AG1213R	\$44.99

	11/12 Micro Mini Gracey	1112MMGIMP	\$129.99
	1/2 Micro Mini Gracey	12MMGIMP	\$129.99
	H6H7 Hygienist Scaler	1175IMP	\$129.99
	204SD Sickle Scaler	1185IMP	\$129.99
	204S Sickle Scaler	1184IMP	\$129.99
	1/2 Langer Universal	1204IMP	\$129.99
	5/6 Barnhart Curette	1214IMP	\$129.99
	13/14 Columbia	1217IMP	\$129.99
	1/2 Mini Gracey	1220IMP	\$129.99
	11/12 Mini Gracey	1225IMP	\$129.99
	13/14 Mini Gracey	1226IMP	\$129.99
	13/14 Micro Mini Gracey	1314MMGIMP	\$129.99
	H5 Langer 5 Mini	H5L5MIMP	\$129.99
	Super Taha (Montana Jack)	STAHAIMP	\$129.99

Our comprehensive range of endodontic hand instruments and accessories is designed to complement your expertise. Whether performing routine root canals or complex microsurgery, these instruments offer precision, durability, and reliability for seamless procedures. Crafted for optimal performance, they help ensure exceptional patient care.

RUBBER DAM CLAMPS

Our Rubber Dam Clamps are crafted from a high-performance steel alloy, ensuring corrosion resistance, exceptional strength, and an ideal balance of flexibility and memory. The matte finish minimizes glare by absorbing light, providing a clear and comfortable field of vision for enhanced precision during procedures.

ENDODONTIC

ENDO EXPLORERS

Our Endodontic Explorers are crafted from a specialized alloy blend, offering optimal flexibility, strength, and tactile sensitivity for precise assessment of the treatment site. Designed for durability and resilience, they come in various double-ended configurations and handle styles to suit different clinical needs.

ENDO EXCAVATORS

Our Endodontic Excavators are designed with extended-length shanks and crafted from high-grade stainless steel for superior durability and precision. Handcrafted for optimal access to the pulp chamber, they enable efficient and effortless dentin removal, enhancing clinical performance.

ENDO SPREADERS

We offer a diverse range of handcrafted spreaders, meticulously crafted from premium stainless steel to precise specifications. Designed for optimal access to even the most challenging canals, they ensure effective compaction of filling material during lateral condensation for reliable endodontic outcomes.

ENDO PLUGGERS

Our pluggers feature diverse working ends, providing enhanced maneuverability and versatility to meet various clinical needs with precision and ease.

ENDO EXPLORERS

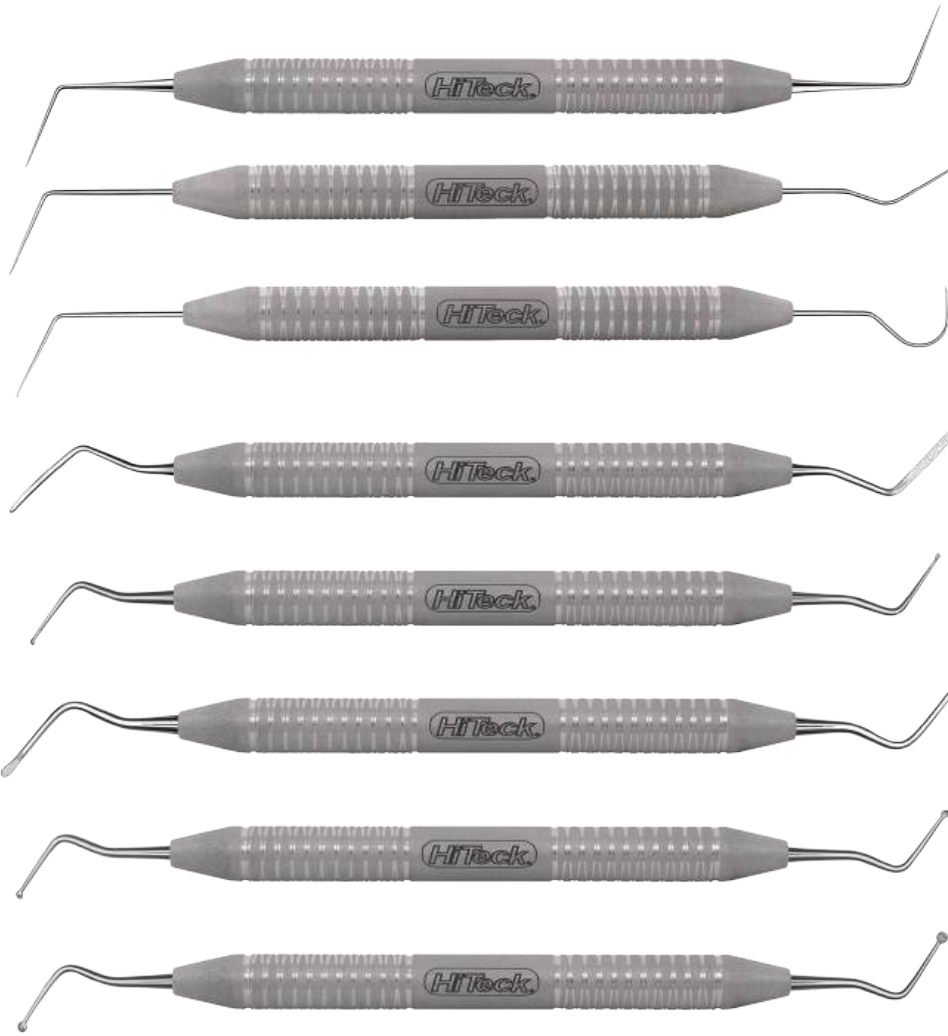

DG 16 Explorer 1119 \$39.99

DG 16/17 Explorer 1120 \$39.99

DG 16/23 Explorer 1121 \$39.99

2 Glick 2405 \$39.99

31L Spoon 2406 \$39.99

31W Oval Spoon 2407 \$39.99

32L Spoon 2408 \$39.99

33L Spoon 2409 \$39.99

ENDO EXCAVATORS

ENDO PLUGGERS

ENDO ACCESSORIES



8A 29mm • 0.40mm 1270 \$39.99

9A 29mm • 0.55mm 1271 \$39.99

10A 29mm • 0.75mm 1272 \$39.99

11A 29mm • 1.05mm 1273 \$39.99

8.5A 29mm • 0.45mm 1274 \$39.99

9.5A 29mm • 0.65mm 1275 \$39.99

10.5A 29mm • 0.90mm 1276 \$39.99

11.5A 29mm • 1.15mm 1277 \$39.99

12A 29mm • 1.30mm 1278 \$39.99













Stainless Steel Ruler ERULE6 \$32.99

6 Inches



Rubber Dam Clamp Organizing Board RDCOB8 \$64.99

Store, sterilize and organize with eight pegs that securely hold your clamps. Dimensions: 4.62" x 2.4" x .375" (117 mm x 61 mm x 10 mm), 8 Pieces.

	ISO Size 30 (24MM/0.3MM)	1262	\$39.99
	ISO Size 40 (24MM/0.4MM)	1263	\$39.99
	ISO Size 50 (24MM/0.5MM)	1264	\$39.99
	ISO Size 60 (24mm)	1265	\$39.99
	1/3 Root Canal Plugger (21mm) 0.4MM/0.45MM	2257	\$39.99
	5/7 Root Canal Plugger (21mm) 0.5MM/0.75MM	2351	\$39.99
	9/11 Root Canal Plugger (21mm) 1.0MM/1.15MM	2352	\$39.99
	L1 18mm (0.45 MM)	1266	\$39.99
	L2 18mm (0.5 MM)	1267	\$39.99
	L3 18mm (0.75 MM)	1268	\$39.99
	L4 18mm (1.00 MM)	1269	\$39.99

8 22mm	• 0.40mm	1279	\$39.99
9 22mm	• 0.55mm	1280	\$39.99
10 22mm	• 0.75mm	1281	\$39.99
11 22mm	• 1.05mm	1282	\$39.99
8.5 22mm	• 0.45mm	1283	\$39.99
9.5 22mm	• 0.65mm	1284	\$39.99
10.5 22mm	• 0.90mm	1285	\$39.99
11.5 22mm	• 1.15mm	1286	\$39.99
12 22mm	• 1.30mm	1287	\$39.99



Stieglitz 1295 \$68.99

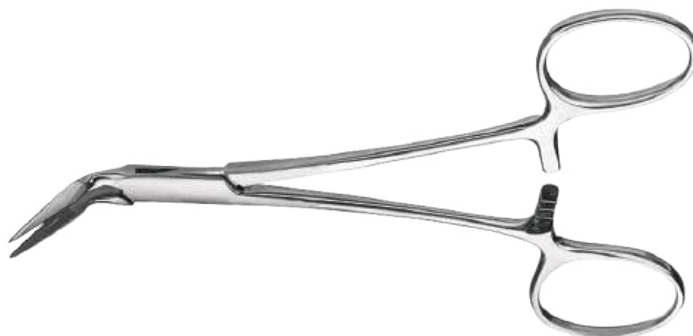

Stieglitz Curved 1296 \$64.99



Stieglitz Angled 1297 \$64.99



Peet Curved 1298 \$64.99



Ivory Lightweight
17cm
1299 | \$92.99



Brewer
17cm
1300 | \$97.99



U of Washington
17cm
1301 | \$97.99



Ring Placement Forcep
17cm
CS11 | \$119.99

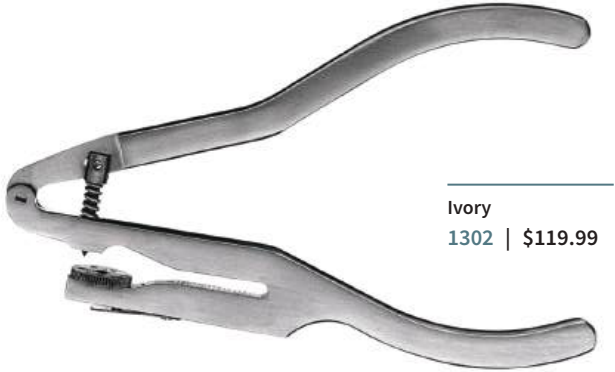

Ivory
1302 | \$119.99



Ainsworth
1303 | \$119.99



Small Child
3.5 inch/9cm
1304 | \$39.99

Child
5 inch/13cm
1305 | \$39.99

Adult
6 inch/15cm
1306 | \$39.99



56
Slightly festooned serrated jaws for large partially erupted or irregularly shaped molars
1341 | \$16.99



56S
Slightly festooned jaws for molars
1342 | \$16.99



W8A
Deeply festooned jaws for partially erupted or irregularly shaped molars
1351 | \$16.99



W14A
Deeply festooned jaws and extended bow for distal access to molars
2231 | \$16.99



8AD
Deeply festooned jaws and extended bow for distal access to molars
2232 | \$16.99



0
Flat jaws and high bow for longer premolars
1308 | \$16.99



1
Slightly festooned jaws for upper premolars
1309 | \$16.99



1A
Deeply festooned jaws for canines and premolars
1310 | \$16.99



2
Flat jaws for premolars
1311 | \$16.99



2A
Flat jaws for larger premolars
1312 | \$16.99



2AS
Flat serrated jaws for larger premolars
1313 | \$16.99



27N
Slightly festooned jaws for premolars
1336 | \$16.99



29
Flat jaws for lower premolars
1338 | \$16.99



W2
Flat jaws for premolars
1347 | \$16.99



209
Small, flat jaws with stiff bow for lower premolars
2233 | \$16.99



4
Flat narrow jaws for small upper molars
1315 | \$16.99



5
Slightly festooned jaws for large upper molars
1316 | \$16.99



8
Deeply festooned jaws for upper molars
1320 | \$16.99



26N
Flat jaws for upper molars
1334 | \$16.99



30
Offset jaws for upper right molars; paired with RDCM31
1339 | \$16.99



31
Offset jaws for upper left molars; paired with RDCM30
1340 | \$16.99



201
Slightly festooned jaws for upper molars
1343 | \$16.99



205
Slightly festooned jaws for large upper molars
1344 | \$16.99



W4
Flat narrow jaws for small upper molars
1349 | \$16.99



0
Flat jaws and high bow for small lower canines and first premolars
1307 | \$16.99



6
Slightly offset jaws for labial caries on anterior teeth
1317 | \$16.99



9
Offset flat jaws and stiff bow for anterior teeth
1322 | \$16.99



9S
Offset flat serrated jaws for anterior teeth
1323 | \$16.99



212
Flat jaws for labial caries on anterior teeth
1345 | \$16.99



212SA
Slightly offset staggered jaws for odd shaped anteriors
1346 | \$16.99



3
Flat narrow jaws for small lower molars
1314 | \$16.99



7
Flat jaws for lower molars
1318 | \$16.99



7A
Slightly reversed festooned jaws for large lower molars
1319 | \$16.99



12A
Serrated offset jaws for lower right molars; paired with RDCM13A
1326 | \$16.99



13A
Serrated offset jaws for lower left molars; paired with RCM12A
1327 | \$16.99



26
Slightly reversed festooned jaws for small lower molars
1333 | \$16.99



28
Flat jaws for lower molars
1337 | \$16.99



W3
Flat narrow jaws for small lower molars
1348 | \$16.99



W7
Flat jaws for lower molars
1350 | \$16.99



8A
Deeply festooned four-point jaws for molars
1321 | \$16.99



10
Flat jaws designed for small upper left and lower right molars; paired with RDCM11
1324 | \$16.99



11
Flat jaws designed for small upper right and lower left molars; paired with RDCM10
1325 | \$16.99



14
Deeply festooned jaws for partially erupted or irregularly shaped molars
1328 | \$16.99



14A
Deeply festooned jaws for partially erupted or irregularly shaped molars; larger than RDCM14
1329 | \$16.99



18
Flat jaws for upper right and lower left molars; paired with RDCM25
1330 | \$16.99



24
Flat jaws for upper left and lower right molars; paired RDCM24
1331 | \$16.99



25
Flat jaws for large molars
1332 | \$16.99



27
Slightly festooned jaws for large molars
1335 | \$16.99

Our restorative instruments are designed to provide precision, durability, and superior handling for a wide range of restorative procedures. Crafted from high quality stainless steel and featuring advanced coatings, these instruments ensure excellent performance and longevity. Our selection includes plastic filling instruments for smooth material application, Siyah black-coated instruments with ALTiN coating for a non-stick, corrosion-resistant surface, and carvers for precise shaping and contouring. Each instrument is meticulously crafted to enhance efficiency, control, and clinical outcomes, ensuring seamless restorative workflows for dental professionals.

SIYAH COMPOSITE INSTRUMENTS

Our Composite Instruments are meticulously designed with an Aluminum Titanium Nitride (ALTiN) coating, ensuring a non-stick, scratch-resistant surface for seamless composite placement. Featuring large yet lightweight handles, they provide exceptional comfort, control, and easy cleanup, making them an essential tool for precise restorative work.

CHISELS & HOES

Chisels are essential for cavity preparation, designed to remove, smooth, and contour tooth structure with precision. They help refine cavity walls for better restorative adaptation. Hoes serve a similar role but offer added versatility, allowing for the removal of calculus and surface stains in addition to shaping and refining cavity preparations.

HATCHETS

Hatchets are precision-engineered restorative cutting instruments designed for refining retentive areas, internal line angles, and cavity preparations. They effectively remove hard caries and unsupported enamel, ensuring smooth, well-defined surfaces for optimal restorative outcomes.

MARGIN TRIMMERS

Margin Trimmers are precision restorative cutting instruments designed to shape enamel margins and create proper bevels for optimal restoration fit. Similar to hatchets but with a curved blade and angled cutting edge, they allow for efficient contouring and precise enamel removal in cavity preparations.

RESTORATIVE

EXCAVATORS

Dental Excavators are essential instruments designed for the removal of softened dentin, debris, and caries during cavity preparation. Featuring sharp, spoon-shaped working ends, they allow for precise excavation while preserving healthy tooth structure. Available in various sizes and angulations, they provide optimal access to deep cavities, ensuring efficient and controlled material removal for better restorative outcomes.

PLACEMENT INSTRUMENTS

Placement Instruments are designed for the precise application of bases and liners within cavity preparations. Their ergonomic design and controlled tip allow for accurate material placement, ensuring a smooth and even foundation for restorations.

PLUGGERS

Pluggers are essential restorative instruments used for packing, condensing, and consolidating filling materials into cavity preparations. Their precise design ensures uniform density and adaptation, enhancing the strength and longevity of restorations.

GINGIVAL RETRACTORS

Gingival Retractors protect tissue during cavity preparation. The concave shape of the tips conform to root surfaces and gingival tissue.

CARVERS

Carvers are designed for shaping anatomical details, contouring surfaces, and trimming excess material in restorative procedures. Their sharp, precise edges ensure smooth, well-defined restorations for optimal function and aesthetics.

CORD PACKERS

Gingival Cord Packers are used to pack retraction cord into the sulcus. The cord packers with round, non-serrated working ends are used for atraumatic cord placement; serrated cord packers should only be used with braided cord.



1 Iwanson Spring Caliper
For metal and porcelain
1783 | \$44.99



Boley Gauge
1785 | \$59.99



2 Iwanson Spring Caliper
For wax
1784 | \$44.99

PKT INSTRUMENTS/MEASURING DEVICES

LeCron Wax Carver
For metal and porcelain
300-127 | \$44.99



Roach Wax Carver
300-128 | \$44.99



Vehe Wax Carver
For wax
300-129 | \$44.99



PKT 1 1928 \$44.99
Curved tapered tips used to flow on molten wax.



PKT 2 1929 \$44.99
Curved tapered tips used to flow on molten wax.



PKT 3 1930 \$44.99
Pointed burnisher used to perfect and enhance the supplemental and developmental grooves.



PKT 3R 1931 \$44.99
Similar to PKT 3, but with a rounded tip vs. a pointed one.



PKT 4 1932 \$44.99
Modified carver used to perfect the external contours and remove excess wax at the cavosurface margins.



PKT 5 1933 \$44.99
Special carver used to remove excess wax as cusp ridges are developed; its contour maintains desired convexity at these ridges.





1 Goldstein 2467 \$57.99

Small universal style with rounded plunger tip and a narrow paddle for initial placement and contouring of Class I, II, and III restorations

2 Goldstein 2468 \$57.99

Larger universal style for final placement and contouring of Class I, II, and III restorations.

3 Goldstein Extra Flex 2469 \$57.99

Flexible, reversed, flared paddle design for shaping and placement of Class III and IV restorations

4 Goldstein Extra Flex 2470 \$57.99

Flexible, paired, offset, paddle-shaped blades for placing and shaping material on posterior, mesial and distal surfaces. Reverse angle is also useful for placing and shaping anterior bonded restorations

5 Goldstein Flexi Thin 300-101 \$57.99

Small reverse angle tips make it easy to place fissures, grooves and pits creating the ideal occlusal anatomy in hard to reach posterior areas.

6 Goldstein Flexi Thin 300-102 \$42.99

Large reverse angle tips make it easy to place fissures, grooves and pits creating the ideal occlusal anatomy in hard to reach posterior areas

1 Mini Goldstein 2473 \$57.99

Mini version of 1 Goldstein for small pits and fissures, tunnel preparations or minor tooth defects on lower anteriors.

2 Mini Goldstein 2474 \$57.99

Mini version of 2 Goldstein. Can also be used for packing gingival retraction cord

3 Mini Goldstein Extra Flex 2475 \$57.99

Mini version of 2 Goldstein. Can also be used for packing gingival retraction cord

4 Mini Goldstein Extra Flex 2476 \$57.99

Mini version of 4 Goldstein for placing and shaping material in difficult to access mesial and distal posterior restorations

AB1 Bhogosian 2363 \$57.99

Unique combination of thin, knife-shaped blade with standard angled blade. Knife blade allows controlled, efficient manipulation of composite even in gingival areas. Application: Class III, IV, V

AB2 Bhogosian 2364 \$57.99

Used for measuring composite layers and shaping occlusal anatomy

W3 2365 \$57.99

Combination of medium-sized blade with small condenser tip for universal adaptability. Ideal for placement, layering and general contouring. Application: Class I, II, III, IV, V

8A 2366 \$57.99

S



4/5 Gregg 2367 \$57.99



Interproximal Carver 2368 \$57.99



Interproximal Carver, Long 2369 \$57.99

Used for placement of the composite increments against the cavity wall or adjacent tooth surface



A6 2370 \$57.99



Contouring Instrument 2371 \$57.99



1 Loesche 1936 \$57.99



2 Loesche 1937 \$57.99



11 Anterior 1938 \$57.99



179 Anterior 1939 \$57.99



1 Woodson 1940 \$57.99



21B Acorn 300-103 \$57.99



27/29 300-104 \$57.99



G Marginal Ridge & Embrasure Shaping Instrument 300-117 \$57.99

Allows formation of marginal ridges along with buccal and lingual embrasures while composite is uncured.



H Occlusal Anatomy Instrument 300-118 \$57.99

Designed to help attain proper occlusal form, function and improve marginal seal.



I Composite Packing Instrument 300-119 \$57.99

Aids in forming a properly filled axial box and occlusal portion.



2 Ladmore 300-105 \$57.99

Medium to large rounded tips for condensing composite materials

3 Ladmore 300-106 \$57.99

Small to medium slightly rounded tips for condensing composite materials

Ball 18 300-107 \$57.99

Used to smooth and shape composite

Freedman Duckhead 300-108 \$57.99

Used to contour the convexity of the cusp ridge, developing the anatomy in a single motion

Freedman Small Contact Forming 300-109 \$57.99

Acorn-shaped instrument for forming occlusal anatomy in posterior restorations

Freedman Large Contact Forming 300-110 \$57.99

Small/Medium Ball 300-132 \$57.99

Small/Medium Contact Forming 300-133 \$57.99

Medium Large Contact Forming 300-134 \$57.99

Rounded cone-shaped instrument to provide improved contact forming for medium/ large Class II restorations

A Cosmetic Contouring 300-111 \$57.99

Identical, opposing, large, flexible, oval shaped blades, straight and angled, for contouring composite material on larger facial surfaces of central incisors.

B Cosmetic Contouring 300-112 \$57.99

Identical, opposing, spear-shaped blades, straight and angled, used for contouring composite material on smaller facial surfaces of central incisors.

C Cosmetic Contouring 300-113 \$57.99

Flexible, oval-shaped blades – one slightly larger – for interproximal contouring on central incisors.



D Cosmetic Contouring 300-114 \$57.99

Used when working near or at interproximal areas. Straight end compacts composite material, while sharp knife edge cuts composite to avoid bonding to adjacent tooth.



E Cosmetic Contouring 300-115 \$57.99

Small and medium curved blades for thinning and shaping composite material at the gingival areas.



F Cosmetic Contouring 300-116 \$57.99

Uniquely-shaped blades with curved and rounded tips for adding and shaping composite material on desired areas of facial incisors.



1 Goldstein 1834 \$44.99



2 Goldstein 1835 \$44.99



3 Goldstein Extra Flex 1836 \$44.99



4 Goldstein Extra Flex 1837 \$44.99



1 Mini Goldstein 1838 \$44.99



2 Mini Goldstein 1839 \$44.99



3 Mini Goldstein Extra Flex 1840 \$44.99



4 Mini Goldstein Extra Flex 1841 \$44.99



2 Woodson 1934 \$44.99



3 Woodson 1935 \$44.99



RESTORATIVE

13/14 1855 \$44.99

2mm



15/16 1856 \$44.99

1.5mm



17/18 1857 \$44.99

1mm



14/14 Off Angle 1860 \$44.99

1.5mm



15/15 Off Angle 1861 \$44.99

1.5mm



26 Distal 1788 \$44.99

1.3mm



27 Mesial 1789 \$44.99

1.3mm



28 Distal 1790 \$44.99

1mm



29 Mesial 1791 \$44.99

1mm



3/4 Wedelstaedt 1794 \$47.99

1.1mm



5/6 Wedelstaedt 1795 \$47.99

1.5mm



1/2 Wedelstaedt 1796 \$47.99

2.0mm



Calcium Hydroxide Placer 2492 \$44.99







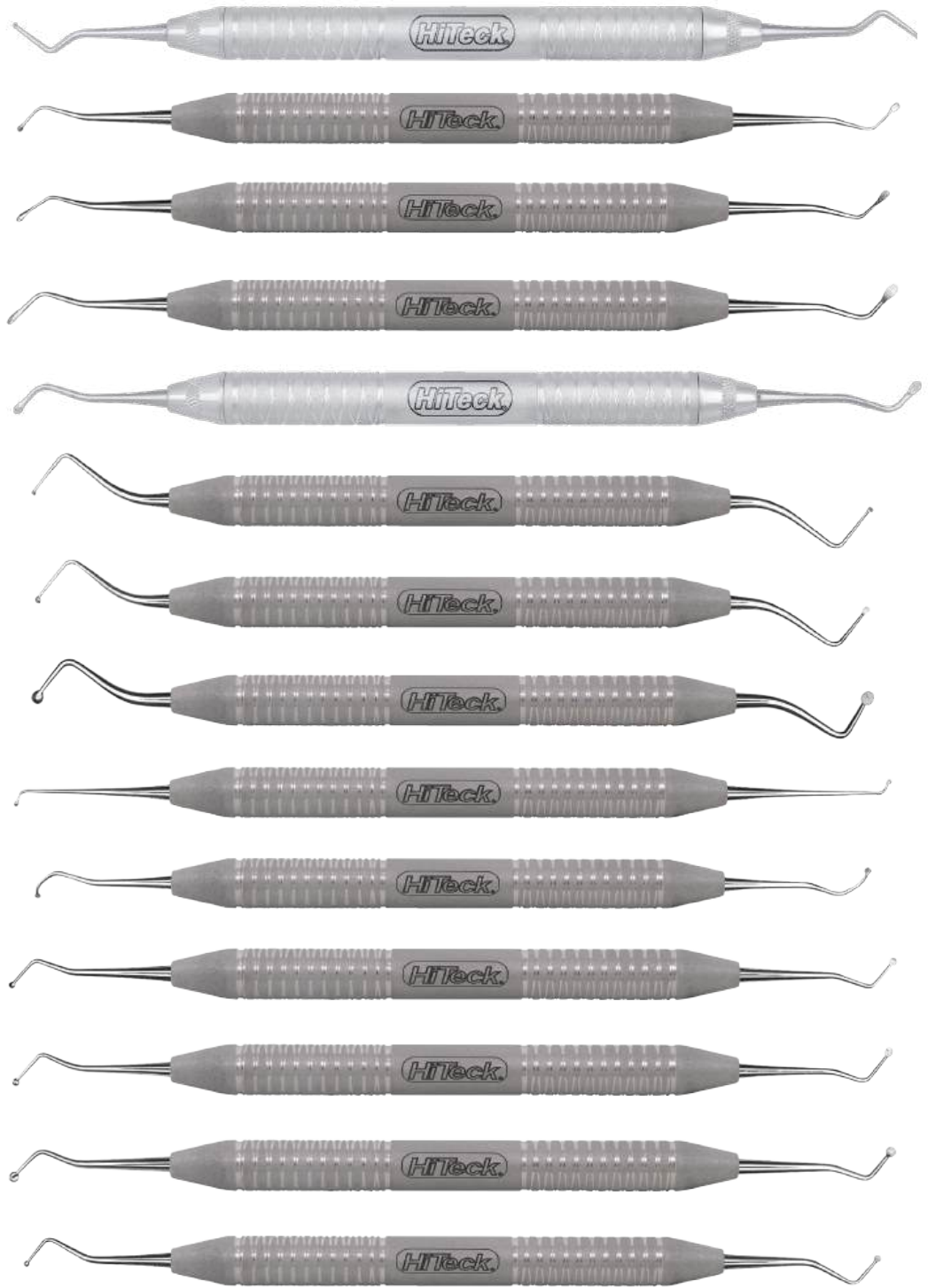











Calcium hydroxide or glass ionomer base/liner placement instrument. Also useful as a small burnisher.



#246	1833	\$44.99
[0.8mm]		
17W	1816	\$44.99
[1.2mm]		
18W	1817	\$44.99
[1.5mm]		
19W	1818	\$44.99
[1.8mm]		
220/221	2361	\$44.99
[1.5mm]		
E1	1807	\$44.99
[12-9-15]		
E2	1808	\$44.99
[15-9-15]		
E3	1809	\$44.99
[25-9-15]		
6	1810	\$44.99
[0.85mm]		
14	1811	\$44.99
[1.4mm]		
17	1812	\$44.99
[1.2mm]		
18	1813	\$44.99
[1.5mm]		
19	1814	\$44.99
[2.0mm]		
38/39	1815	\$44.99
[1.15mm]		



153/154	1829	\$44.99
[1.0mm]		
243	1830	\$44.99
[1.0mm]		
244	1831	\$44.99
[1.4mm]		

	36/37 [15-8-14]	1819	\$44.99
	40/41 [11-7-14]	1820	\$44.99
	44/45 [20-9-14]	1821	\$44.99
	61/62 [2.0 mm]	1822	\$44.99
	63/64 [1.5 mm]	1823	\$44.99
	65/66 [10-6-12]	1824	\$44.99
	125/126 [2.5mm]	1825	\$44.99
	127/128 [2.0mm]	1826	\$44.99
	129/130 [1.7mm]	1827	\$44.99
	131/132 [1.4mm]	1828	\$44.99
	245 [2.0mm]	1832	\$44.99
	1/2 Andrews [1.4mm], [2.0mm]	1874	\$44.99
	H1 Hollenback [1.0mm], [1.65mm]	1875	\$44.99
	H2 Hollenback [2.0mm], [2.7mm]	1876	\$44.99
	H3 Hollenback [2.5mm], [2.5mm]	1877	\$44.99
	H4 Hollenback [1.8mm], [2.4mm]	1878	\$44.99
	0/1 Marquette [1.0mm], [1.4mm]	1879	\$44.99
	2 Mortonson [0.6mm], [1.2mm]	1880	\$44.99

\$39

2 Ward 1892 \$44.99

[2.2mm], [3.0mm]



3 Ward 1893 \$44.99

[1.5mm], [1.9mm]



1T Tanner 1896 \$44.99

[0.6mm], [0.76mm]



2T Tanner 1897 \$44.99



3T Tanner 1898 \$44.99



9/10 Back Action 1899 \$44.99

[1.2mm], [1.6mm]



11/12 Back Action 1900 \$44.99

[1.5mm], [2.0mm]



153 Serrated 1901 \$44.99

[1.5mm], [2.5mm]



154 Serrated 1902 \$44.99

[1.4mm], [2.4mm]



1/2 Black 2373 \$44.99

[1.5mm], [2.5mm]



1/2 Serrated 2374 \$44.99

[1.5mm], [2.5mm]



0/1 Marquette Serrated 2375 \$44.99

[1.0mm], [1.4mm]



2 Serrated Smith 2376 \$44.99

[1.5mm], [1.5mm]



SPO Serrated 76MM 2377 \$44.99

[1.4mm], [2.0mm]



1 Oregon 1887 \$44.99

[0.9mm], [1.2mm]



2 Oregon 1888 \$44.99

[1.0mm], [1.6mm]



3 Oregon 1889 \$44.99

[1.3mm], [2.2mm]

RESTORATIVE

Miller
Articulating
Paper Forcep 1786 \$39.99



Non Slip 1871 \$44.99



Christensen Crown Remover 2603 \$109.99

Straight

Christensen Crown Remover 2604 \$109.99

Right Angled



Temporary Crown Remover 1805 \$164.99



Crown Removing Pliers, 14cm 1806 \$109.99



Trial Lower Crown Remover 2605 \$154.99



Trial Upper Crown Remover 2606 \$154.99



24 Flexible (44mm) 1924 \$39.99

Flexible blade for mixing medium body cements.



324 Rigid (51mm) 1925 \$39.99

Rigid blade for mixing heavier or medium body cements.



A6 Rigid (25mm) 1926 \$39.99



7 Tapered 1927 \$39.99



8R Rigid 300-130 \$39.99



5A Knife 300-131 \$39.99

AMALGAM

CHRISTENSEN
CROWN REMOVERS

TEMPORARY CROWN REMOVERS

SPATULAS & KNIVES

21 Acorn **1917** \$44.99



21B Acorn **2314** \$44.99



18 **1918** \$44.99



26/27S **1919** \$44.99



27/29 **1920** \$44.99



28/29 **1921** \$44.99



2 Beavertail **1914** \$44.99



2 Double Ended Beavertail **1915** \$44.99



2/29 Beavertail **1916** \$44.99



2 Ladmore **1922** \$44.99



3 Ladmore **1923** \$44.99



Straight Interproximal **300-123** \$109.99

For anterior crown removal.



45° Angle **300-124** \$109.99

For cuspids, bicusps and even first molars.



Occlusal **300-125** \$109.99

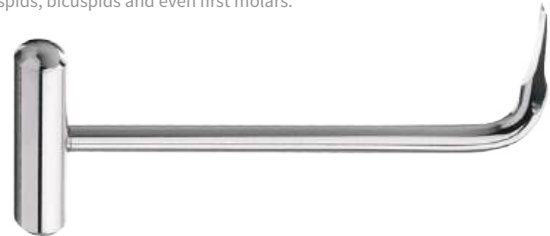

Right Angle **300-126** \$109.99

For molars.

For

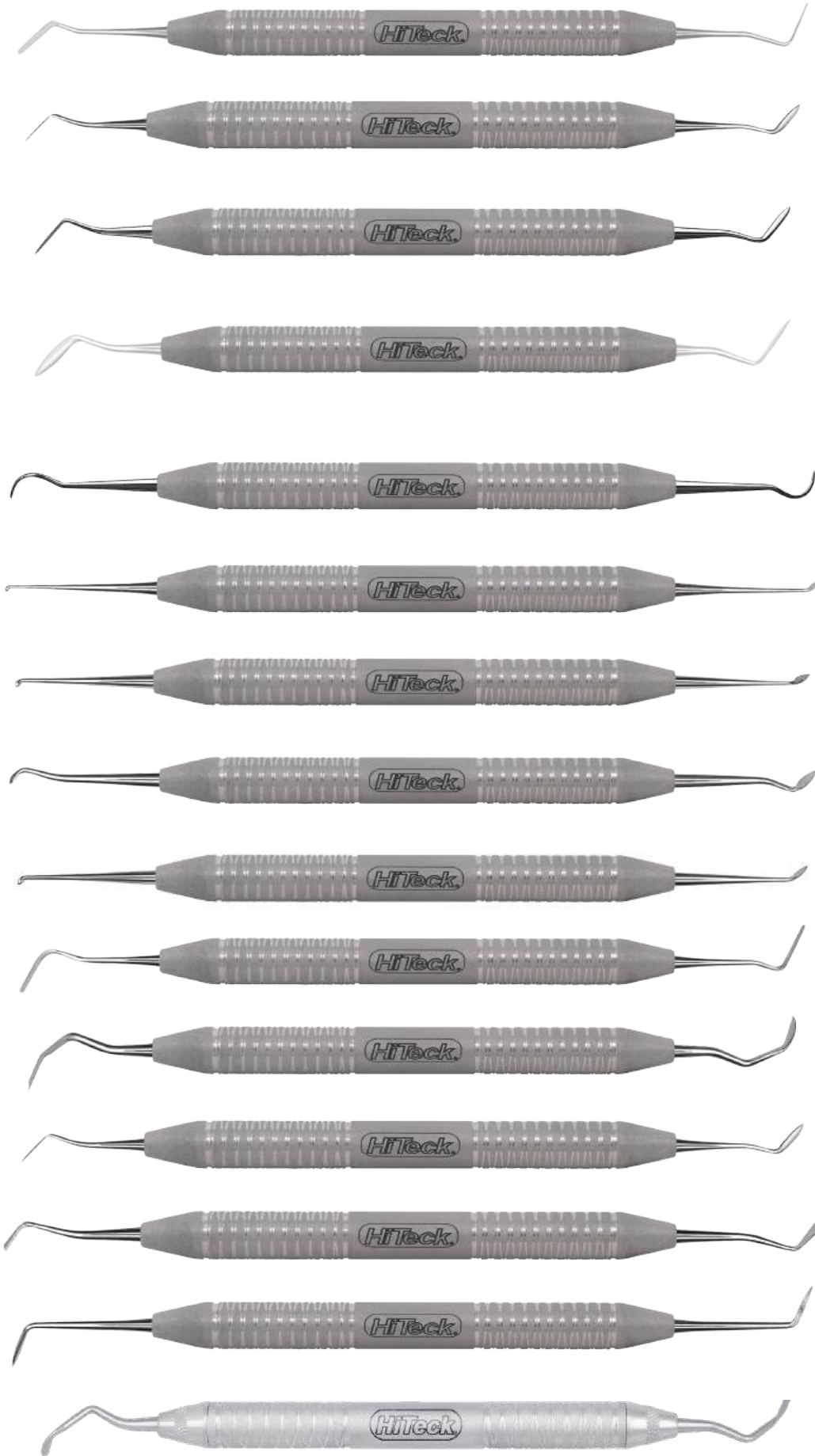

Interproximal	1903	\$44.99
Extremely thin, flexible blade; ideal for interproximal contouring.		
1/2 Hollenback	1904	\$44.99
Universal adaptability. Ideal for placing, carving and contouring amalgam.		
3S Hollenback Carver	1905	\$44.99
Design characteristics similar to 1/2 Hollenback but with slightly larger blades.		
3 Hollenback Carver	1906	\$44.99
Design characteristics similar to 1/2 Hollenback but with significantly larger blades. Hollenback but with significantly larger blades.		
8 Wiland	1907	\$44.99
Extremely thin curved blade; ideal for adapting to interproximal surfaces.		
1/2 Discoid Cleoid	1908	\$44.99
4/5 Discoid Cleoid	1909	\$44.99
3/6 Discoid Cleoid	1910	\$44.99
89/92 Discoid Cleoid	1912	\$44.99
Interproximal Off Angle	2378	\$44.99
Extremely thin, flexible blade. Off-angle provides better access to posterior areas.		
6 Tanner	2382	\$44.99
1 Hollenback	2395	\$44.99
2 Hollenback	2396	\$44.99
L7 Levy Carver	2397	\$44.99
21 Aesthetic Carving Knife	2454	\$47.99

Orthodontics is a demanding specialty, requiring precision, efficiency, and patient-centered care. We provide innovative solutions to help streamline your workflow, including our Clear Aligner Instruments, designed for enhanced accuracy and control when working with clear aligners. Crafted with ergonomic designs for superior handling, our instruments ensure a comfortable experience for both clinicians and patients. By optimizing performance and reducing strain, they help create a smooth, stress-free treatment environment, allowing you to focus on delivering exceptional results with confidence.

CLEAR ALIGNER PLIERS

Our Clear Aligner Instruments are expertly designed to enhance, customize, and optimize the biomechanics of clear aligners—no heat required. These innovative tools allow for precise adjustments, ensuring a tailored fit and improved treatment efficiency for a seamless aligner experience.

CUTTERS

Our precision-engineered cutters feature razor-sharp, accurately aligned cutting edges for consistent performance in every procedure. Designed for specific areas of focus, each cutter is crafted to deliver optimal results for its intended wire size. To ensure superior cutting efficiency, all blades are hand-finished to meet the highest standards of precision and durability.

ORTHODONTIC

UTILITY PLIERS

Strong yet lightweight, our Utility Pliers are meticulously crafted for perfect balance and precision. Designed with ideal proportions for a natural grip, they provide superior control and effortless versatility. Engineered for both clinician comfort and patient ease, these pliers ensure a seamless experience in every procedure.

WIRE FORMING PLIERS

Our precision-crafted instruments function as a seamless extension of your expertise, allowing for precise wire bending without risk of damage. Featuring impeccably smooth, hand-finished tips, they provide exceptional control and accuracy when shaping stainless steel or nickel titanium. Designed to enhance your skill and craftsmanship, these instruments help bring your work to life with precision and confidence.

MATHIEUS

Crafted with the same precision and attention to detail as our pliers, our Mathieu needle holders are forged from high-quality German steel, ensuring exceptional durability and resistance to rust and corrosion. Designed for precision and longevity, they provide reliable performance in every procedure.

HAND INSTRUMENTS

Our Orthodontic hand instruments feature a meticulously designed ergonomic handle, offering optimal comfort, balance, and control. Crafted with precision and excellence, each instrument is engineered for superior performance, ensuring accurate tip alignment and reliable functionality in every procedure.



The Tear Drop
400-101 | \$179.99

An instrument created to add a notch at the gingival margin of clear aligners anywhere elastic hooks are required within the arch. The Tear Drop provides a reservoir to hold the elastics in place as the aligner is seated. This permits easier manipulation of elastics by the patient.



The Horizontal
400-103 | \$179.99

The Horizontal instrument produces an indentation to accent individual root torque. It also serves a second purpose by enhancing retention of either clear aligners or retainers by placing an indent into a tooth's undercut or below a bonded attachment to enhance the contact of the aligner to that attachment.



The Hole Punch
400-104 | \$179.99

The Hole Punch is used to create 6mm half-moon cutouts for relief of clear aligners around bonded buttons used for elastics. No need to attempt to attach buttons to plastic trays. In addition, the Hole Punch can nip away plastic to provide soft tissue clearance to prevent aligner impingement of tissue.



The Spot
678-804 | \$179.99

The Spot creates a tiny, rounded dimple for spot contacts to accent small individual tooth movements or added aligner retention. It is typically used to accent movements on any tooth that just needs a slight "nudge". The Spot's small depression placed adjacent to the gingival embrasures can also enhance the retentiveness of an aligner or retainer.



The Vertical
400-102 | \$179.99

Correcting rotations is often a challenge with aligners. The Vertical emphasizes over-correction of rotations by producing an indentation at the mesial or distal line angles on the facial and/or lingual of a specific tooth. As an option, a rotational couple can also be created using vertical indents on facial and lingual surfaces on opposing sides of a tooth. The Vertical can also be used to produce an indent to produce a mild "nudge" to enhance resolution of in-and-out discrepancies. It can also be used to apply an indent immediately next to an attachment to enhance the adaptation of the aligner to angle between that attachment and the aligner.



**The Counter
Clockwise Wedge**
678-807 | \$179.99

The Counter Clockwise Wedge is used to produce a wedge-shaped indent in an aligner at the facial and at the opposite line angle lingual for a specific tooth to create a rotational couple. Used to create a counter clockwise rotation.



The Eraser
678-811 | \$179.99

The Eraser is designed to reverse or remove unwanted indents placed by other instruments in the Clear Aligner Series. The Eraser is designed to flatten the plastic where a depression was inadvertently positioned, or the accent is no longer required.



The Petite Punch
678-805 | \$179.99

The Petite Punch cuts a 4.5mm half-moon cutout in an aligner for relief of the plastic around bonded buttons used for elastics. When only a small cut-out is required to provide clearance for buttons or hooks on the buccal but also on the lingual of any tooth in the aligner, especially for smaller teeth. The Petite Punch can also nip away plastic to provide soft tissue clearance to prevent aligner impingement of tissue.



The Clockwise Wedge
678-808 | \$179.99

The Clockwise Wedge is used to produce a wedge-shaped indent in an aligner at the facial and at the opposite line angle lingual for a specific tooth to create a rotational couple. Used to create a clockwise rotation.



Universal Cut & Hold Distal End Cutter

400-105 | \$179.99
400-105L | \$179.99



Hard Wire Cutter, 15°
400-108 | \$179.99



Micro-Mini Pin & Ligature Cutter
400-111 | \$179.99
400-111L | \$179.99



Flush Cut Distal End Cutter, No Hold
400-106 | \$179.99



Multi Use Pin & Ligature Cutter
400-107 | \$179.99



Mini Pin & Ligature Cutter
400-109 | \$179.99



Hard Wire Cutter
400-110 | \$179.99



Micro-Mini Pin & Ligature Cutter, 15°
400-113 | \$179.99



Slim Micro Cutter
400-114 | \$179.99



Micro Cutter
400-115 | \$179.99



Lingual Distal End Cutter
400-116 | \$179.99



Lingual Pin & Lig Cutter
400-118 | \$179.99



Flush Cut & Hold Distal End Cutter
678-111 | \$179.99



Band Crimping Pliers
400-134 | \$169.99



Weingart Pliers
400-119 | \$169.99



Adhesive Removing Pliers
400-124 | \$169.99

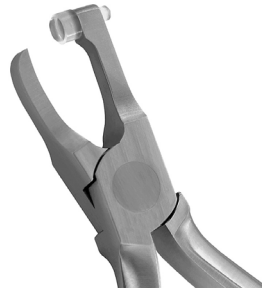

Posterior Band Removing Pliers, Long
400-125 | \$169.99



Bracket Removing Pliers
400-130 | \$169.99



Slim Weingart Pliers
400-120 | \$169.99



Weingart Pliers, Long Handle
400-119L | \$169.99



How Pliers
400-121 | \$169.99



How Pliers, Offset
400-122 | \$169.99



Band Seating Pliers
400-123 | \$169.99



Posterior Band Removing Pliers, Short
400-126 | \$169.99



Crown & Band Contouring Pliers
400-132 | \$169.99



Angulated Bracket Removing Pliers
400-131L | \$169.99



Lingual Bracket Removing Pliers
400-139 | \$169.99



Force Module Separating Pliers
678-210 | \$169.99



Coon Style Ligature Tying Pliers
678-211 | \$169.99



Steiner Tying Pliers
678-222 | \$169.99



Slim Crown & Band Contouring Pliers
400-132M | \$169.99



Ultra Slim Weingart Pliers
400-135 | \$169.99



Slim Band Removing Pliers
400-136 | \$169.99



Lingual Weingart Pliers
400-137 | \$169.99
90 Degree Bend



Bird Beak Pliers
400-142 | \$169.99



Tweed Loop Forming Pliers
400-144 | \$169.99



Three Jaw Pliers
400-140 | \$169.99



Omega Loop Forming Pliers
400-141 | \$169.99



Light Wire Bird Beak Pliers with Groove
400-143 | \$169.99



Mini Three Jaw Pliers
400-150 | \$169.99



Arch Bending Pliers
400-145 | \$169.99



Tweed Pliers, Slim
400-145S | \$169.99



Rectangular Arch Bending Pliers
400-146 | \$169.99



Hollow Chop Contouring Pliers
400-148 | \$169.99



Torquing Pliers
400-164 | \$169.99
.016"/.018" Key
400-165 | \$169.99
.018"/.022" Key



Step Pliers
400-166 | \$169.99
1/2 MM
400-167 | \$169.99
3/4 MM
400-168 | \$169.99
1 MM



NiTi Three Jaw Pliers
400-158 | \$169.99



Light Wire Bird Beak Pliers
400-154 | \$169.99



Bird Beak Pliers with Cutter
400-161 | \$169.99



Adams Pliers
400-156 | \$169.99



Long Tapered Bird Beak Pliers
400-162 | \$169.99



Hammerhead NiTi Tie-Back Pliers
400-163 | \$169.99



Lingual Hammerhead NiTi Pliers
400-170 | \$169.99
400-170SER | \$169.99

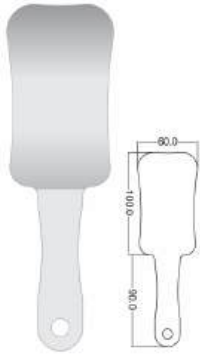

Occlusal-Small with Handle,
60x90x100MM
HMSM-304 | \$129.99

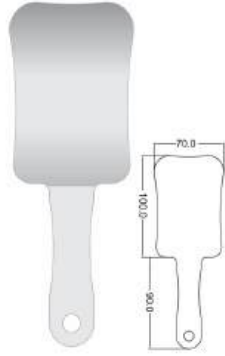

Occlusal-Medium with Handle,
70x90x100MM
HMSM-204 | \$129.99

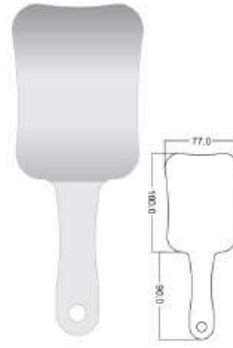

Occlusal-Large with Handle,
77x90x100MM
HMSM-104 | \$129.99

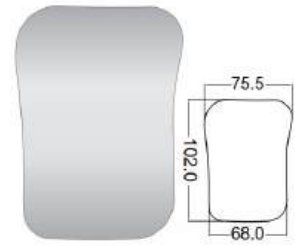

C-Occlusal Adult 75.5x68x102MM
HMSM-305 | \$129.99

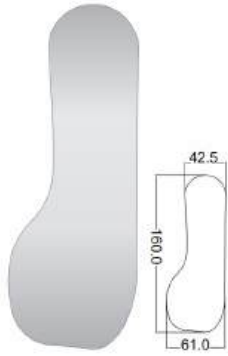

A-Lingual
42.5x61x160MM
HMSM-105 | \$129.99

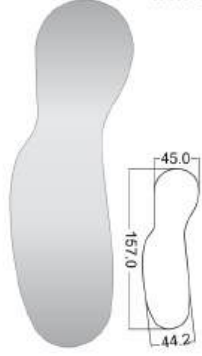

B-Buccal 45x44.2x157MM
HMSM-205 | \$129.99



Adult/Child Squared Occlusal, 150° angle
HMSM-307 | \$129.99



Child Occlusal/Buccal 150° angle
HMSM-707 | \$129.99

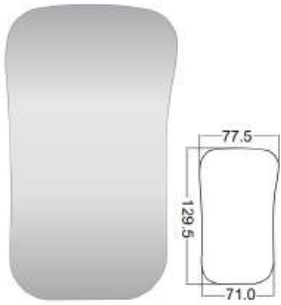

D-Occlusal XL Adult 77.5x71x-129.5MM
HMSM-405 | \$129.99

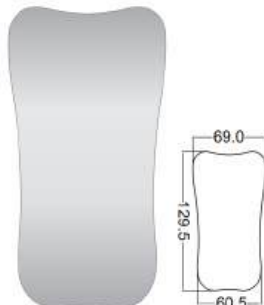

E-Occlusal Medium
69x60.5x129.5MM
HMSM-505 | \$129.99

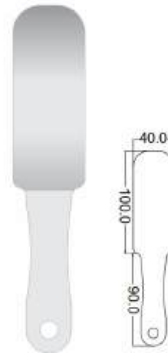

Lateral Photography
40x90x100MM
HMSM-404 | \$129.99



Adult/Child Rounded Occlusal, 150° angle
HMSM-107 | \$129.99



Adult/Child Buccal 150° angle
HMSM-607 | \$129.99



Adult Occlusal/Buccal 150° angle
HMSM-407 | \$129.99



Lingual Upper/Lower 150° angle
HMSM-507 | \$129.99



Buccal 150° angle
HMSM-207 | \$129.99



Crown & Gold Scissor, 12CM
 SCGC | Curved | \$89.99
 SCGS | Straight | \$89.99

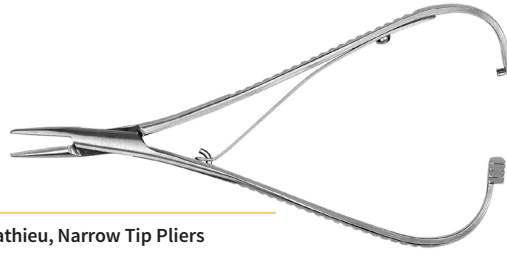

Ortho Mathieu, Narrow Tip Pliers
 400-174 | Narrow Tip | \$99.99
 400-175 | Wide Tip | \$99.99
 400-176 | Tungsten Carbide | \$149.99

Crown & Gold Scissors, Pedro
 400-178 | \$99.99



Lingual Mathieu Pliers
 400-177 | \$99.99

Direct Bond Bracket Holder
 400-180 | \$59.99



Slim Direct Bond Bracket Holder
 400-181 | \$59.99



Slim Buccal Tube Bonder Tweezers
 400-183 | \$59.99



Wire-Cutting Scissors
 400-179 | \$119.99

Band Pusher with Short tip
 400-198 | \$74.99

Scaler/Band Pusher
 400-187 | \$44.99

Ligature Director Scaler
 400-188 | \$44.99

Dull Scaler/Band Pusher
 400-189 | \$44.99

Ligature Director/Band Pusher
 400-191 | \$44.99

Large Plugger/Picker
 400-192 | \$44.99

Dull Scaler
 400-193 | \$44.99

Dull Scaler (H6/7)
 400-194 | \$44.99

Picker/Ligature Director
 400-196 | \$44.99

Band Pusher Short Tip/Scaler
 400-200 | \$44.99

Distal Clinch Back Hand Instrument
 400-184 | \$44.99



SAVE TIME, GROW YOUR PRACTICE WITH OUR INSTRUMENT MANAGEMENT CASSETTES.

INSTRUMENT

HiTeck's Instrument Management Cassettes can help you streamline your office's reprocessing work flow, saving you valuable time with each reprocessing cycle.

Have a look at the comparison chart below to see how much time you can save with each reprocessing cycle. Multiply that by the amount of procedures you do in a day, and you can save a lot of time.

TOTAL TIME SAVED : 11 MINS

To Learn More About Our Instrument Management Cassettes

Visit www.hiteckmedical.com

Manual

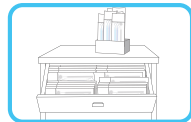
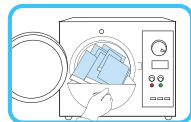
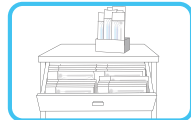
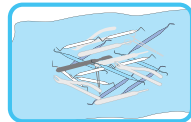
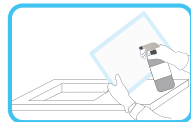

Vs

Hiteck Instrument Management Cassettes

Manual Wash/
Ultrasonic

**3 MINS
SAVED**

Rinse

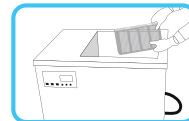

Disinfect Tray

**2 MINS
SAVED**

Dry

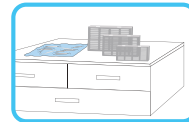

Instrument
Sorting

**3 MINS
SAVED**

Pouch/Wrap

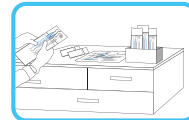

Autoclave

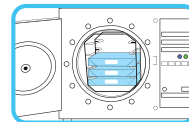

Prep Tray/
Find Instruments

**3 MINS
SAVED**

Chairside



MANAGEMENT

Our Cassette-Based Instrument Management System streamlines the workflow from cleaning to chairside, enhancing efficiency and safety by minimizing direct handling of contaminated instruments. By eliminating multiple time-consuming steps, cassettes help save 5 to 10 minutes per procedure, reduce sharps injuries, and preserve instrument integrity. This system not only increases productivity but also supports compliance with infection prevention standards, ensuring a safer and more cost-effective practice.

ANATOMY OF HITECK'S PREMIUM SERIES CASSETTE

Designed for performance & Durability, our Siyah line of surgical instruments are engineered with Aluminum Titanium Nitride to optimize clinical outcomes. From reducing light reflection to enhancing visibility at the surgical site, the Siyah line was created with the clinician in mind.

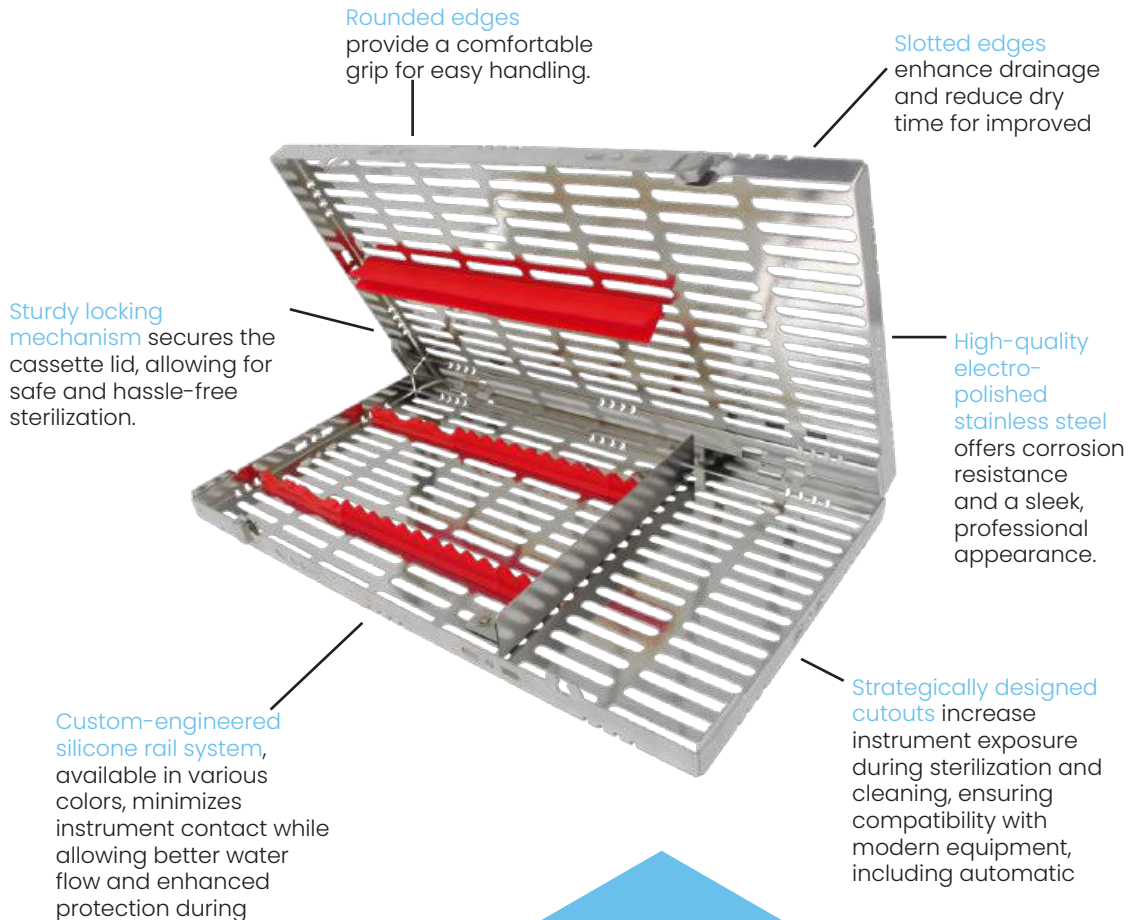

Exam Cassette for 5 Instruments

HMCT-1605 | \$164.99

Exterior Dimensions 3" x 8" x 1.25"
(200 mm x 80 mm x 32 mm)

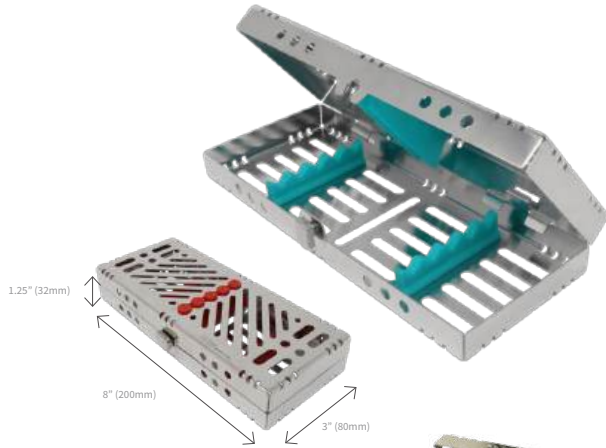

Small Cassette for 7 Instruments

HMCT-1607 | \$169.99

Exterior Dimensions 8" x 3.5" x 1.25"
(200 mm x 90 mm x 32 mm)

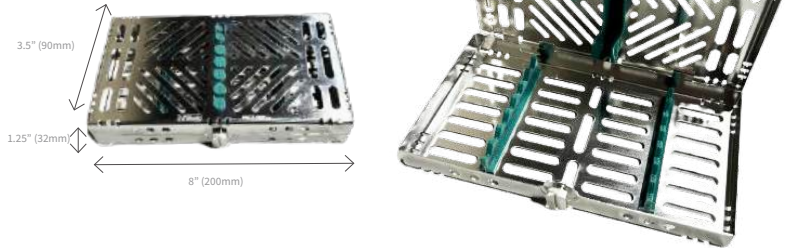

Small Cassette for 10 Instruments

HMCT-1610 | \$179.99

Exterior Dimensions 5.5" x 8" x 1.25"
(140 mm x 203 mm x 32 mm)

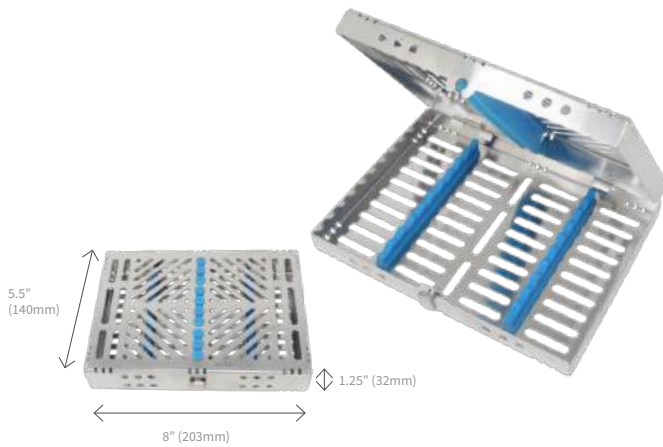

Large Cassette for 20 Instruments

HMCT-1620 | \$239.99

Exterior Dimensions 8" x 11" x 1.25"
(203 mm x 280 mm x 32 mm)

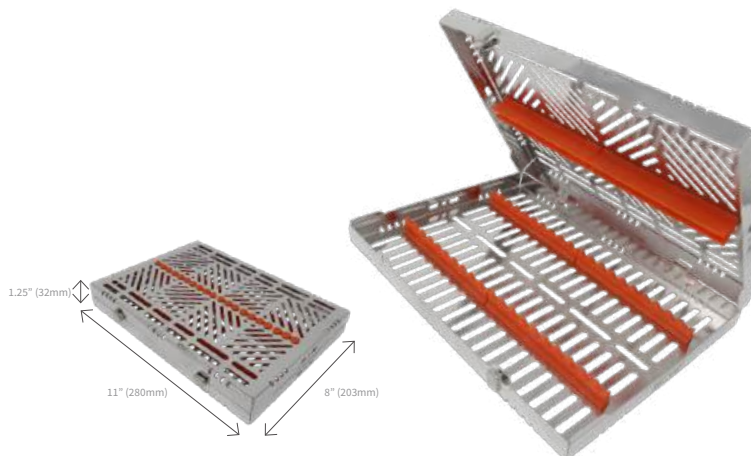

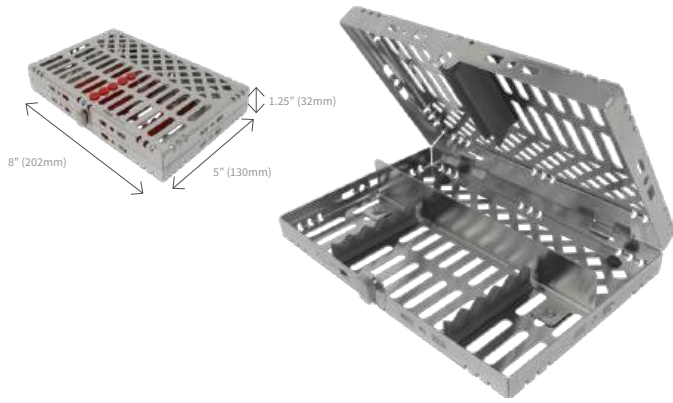

Exam Cassette for 5 Instruments & Accessory Area

HMCT-2205 | \$189.99

Exterior Dimensions 8" x 5" x 1.25"
(202 mm x 130 mm x 32 mm)

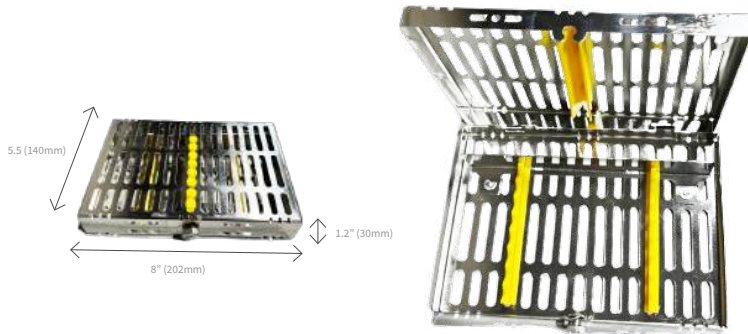

Sterilization Cassette for 8 Instruments & Accessory

HMCT-2208 | \$189.99

Exterior Dimensions 8" x 5.5" x 1.2"
(202 mm x 140 mm x 30 mm)

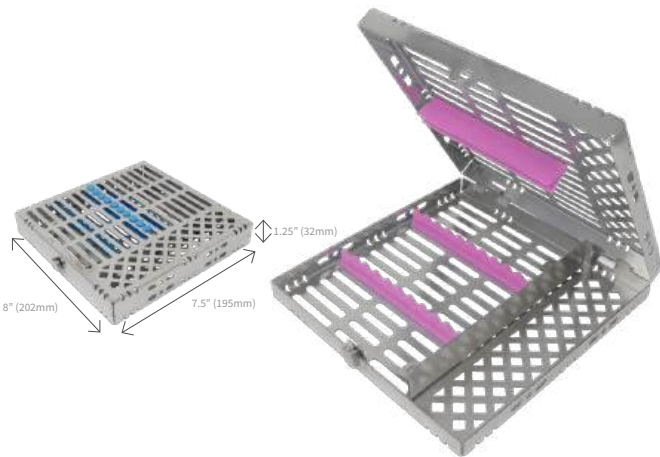

Small Cassette for 10 Instruments & Accessory Area

HMCT-2210 | \$224.99

Exterior Dimensions 8" x 7.5" x 1.25"
(202 mm x 195 mm x 32 mm)

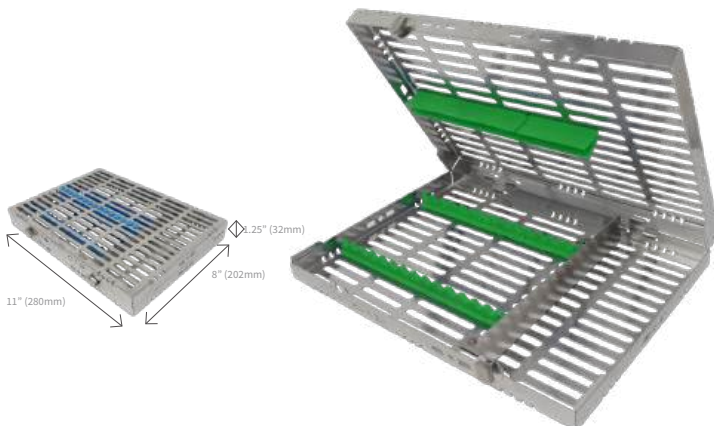

Large Cassette for 16 Instruments & Accessory

HMCT-2216 | \$254.99

Exterior Dimensions 8" x 11" x 1.25"
(202 mm x 280 mm x 32 mm)



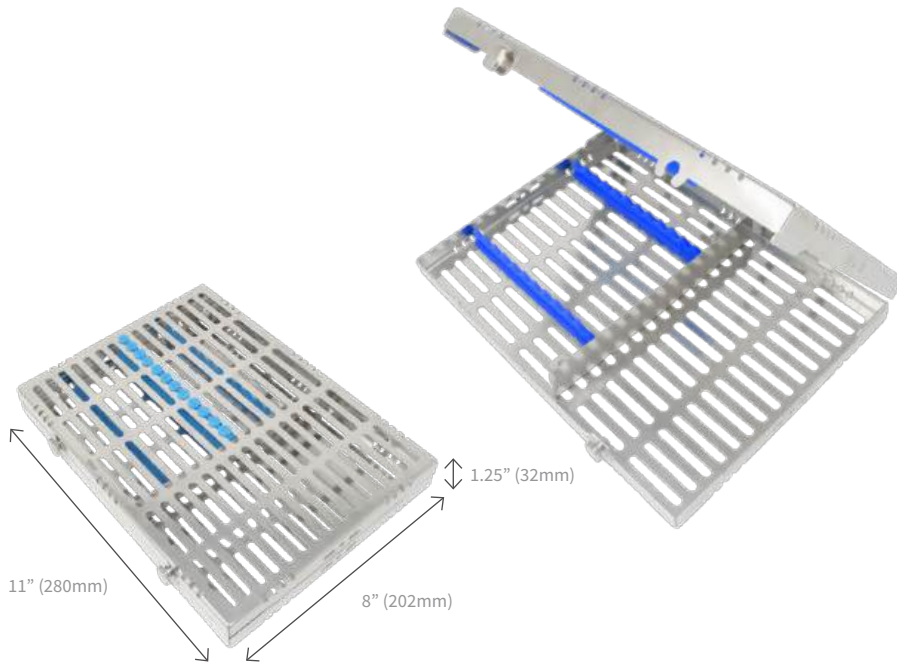

Large Cassette for 12 Instruments & Accessory

HMCT-2212 | \$249.99

Exterior Dimensions 8" x 11" x 1.25"
(202 mm x 280 mm x 32 mm)



Sterilization Cassette for 12 Instruments with Accessory Area, Detachable

HMCT-2212MC | \$249.99

Exterior Dimensions 6.5" x 10.5" x 1.25"
(165 mm x 267 mm x 32 mm)



Large Cassette for 20 Instruments & Accessory

HMCT-2220 | \$419.99

Exterior Dimensions 8" x 14.5" x 1.25"
(230 mm x 368 mm x 32 mm)

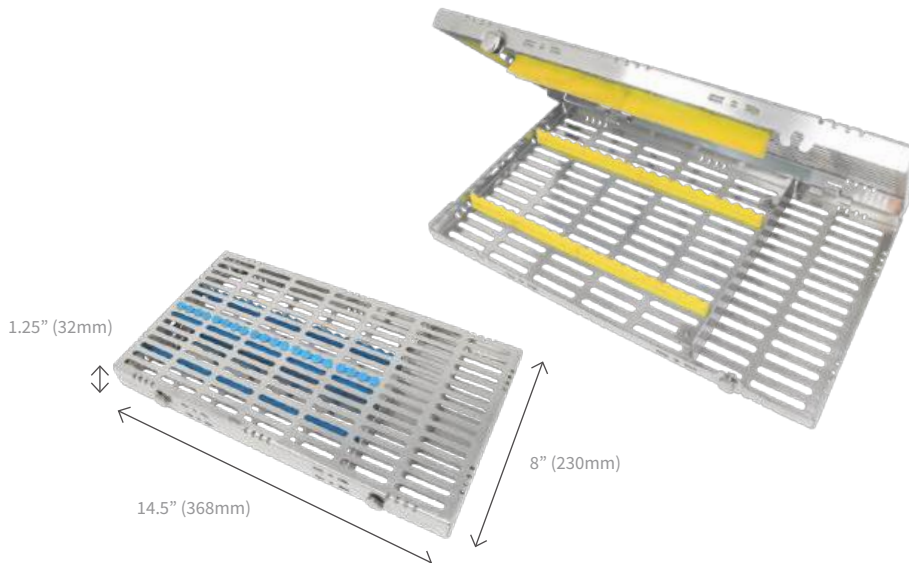

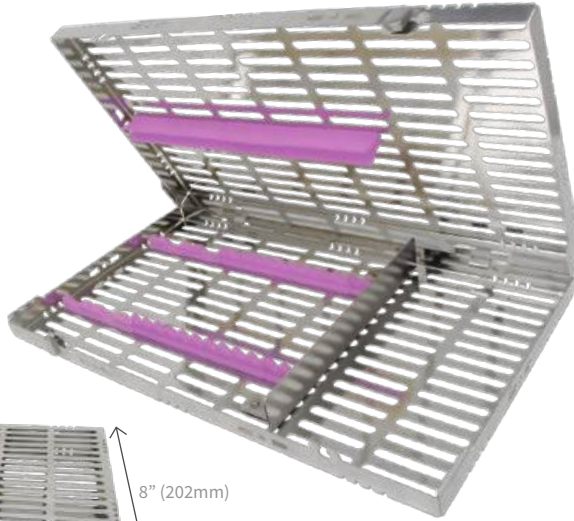

Oral Surgery Cassette

HMCT-2214 | \$419.99

Exterior Dimensions 8" x 14.5" x 1.25"
(202 mm x 280 mm x 32 mm)

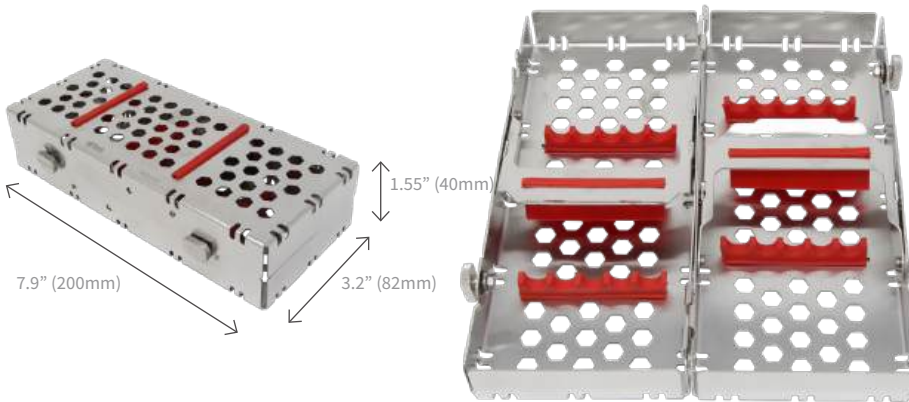
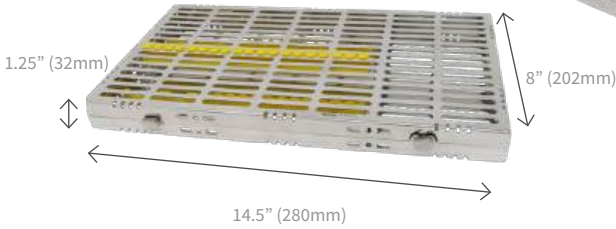

Small Twin Cassette - Holds 10 Instruments

HMSCT-1910 | \$239.99

Exterior Dimensions 7.9" x 3.2" x 1.55"
(200 mm x 82 mm x 40 mm)

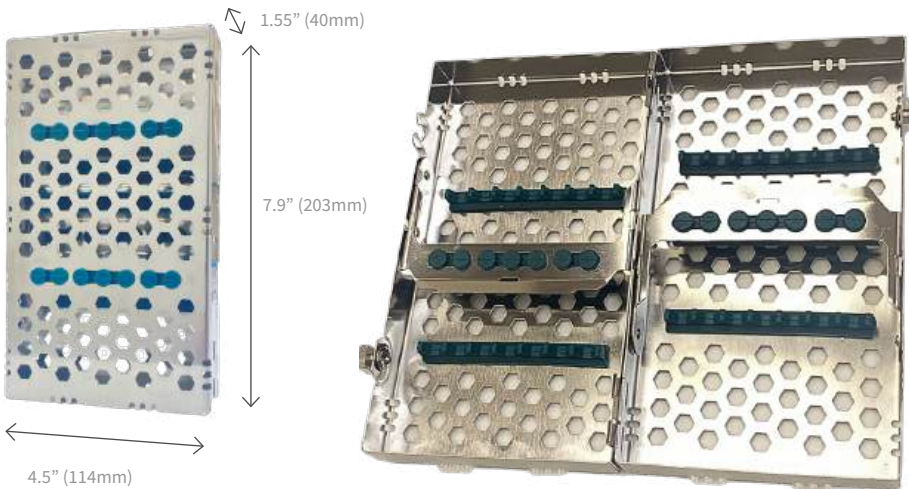
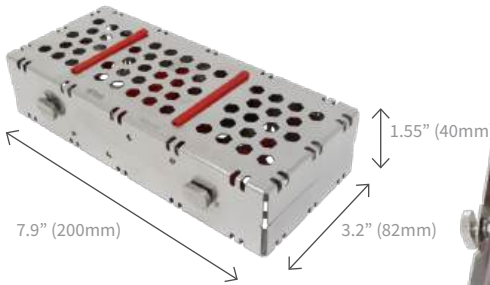

Medium Twin Cassette - Holds 14 Instruments

HMSCT-1914 | \$249.99

Exterior Dimensions 7.9" x 4.5" x 1.55"
(114 mm x 203 mm x 40 mm)

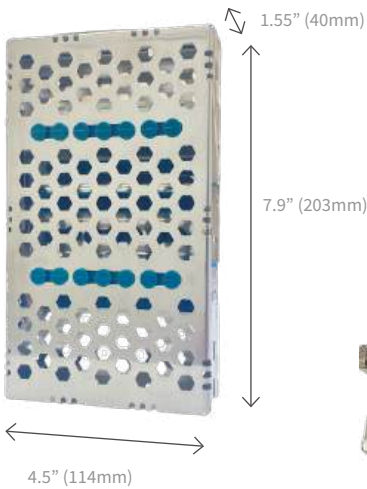

Large Twin Cassette - Holds 20 Instruments

HMSCT-1920 | \$259.99

Exterior Dimensions 7.9" x 5.2" x 1.55"
(200 mm x 132 mm x 40 mm)

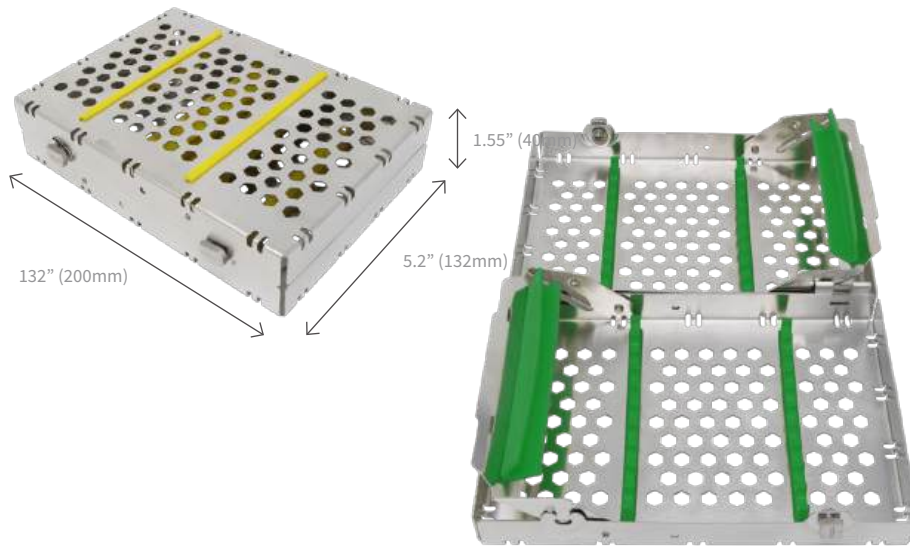

Small Thin Orthodontic Cassette

HMCT-4ORTH | \$239.99

Exterior Dimensions 7" x 8" x 0.75"
(178 mm x 203 mm x 19 mm)

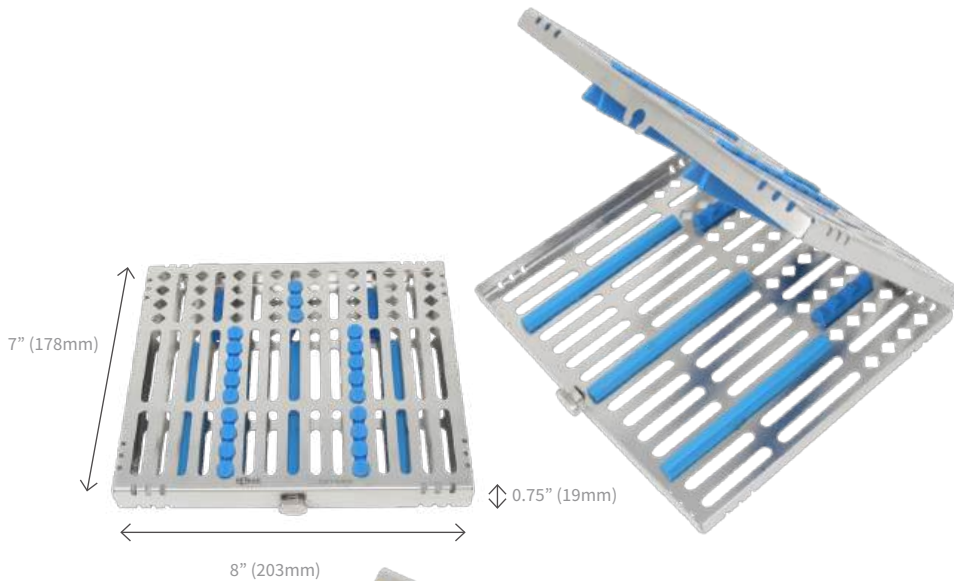

Large Thin Orthodontic Cassette

HMCT-7ORTH | \$259.99

Exterior Dimensions 8" x 11" x 0.75"
(203 mm x 280 mm x 19 mm)

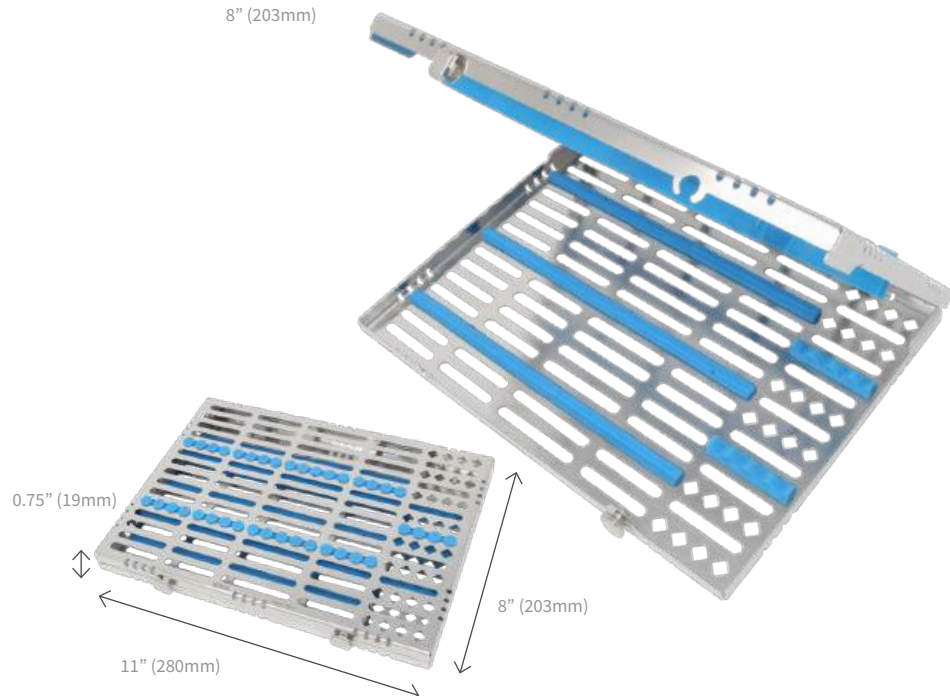

Mini Exam Cassette for 3 Instruments

HMCT-1403 | \$84.99

Exterior Dimensions 7" x 2.2" x 0.9"
(180 mm x 55 mm x 22 mm)

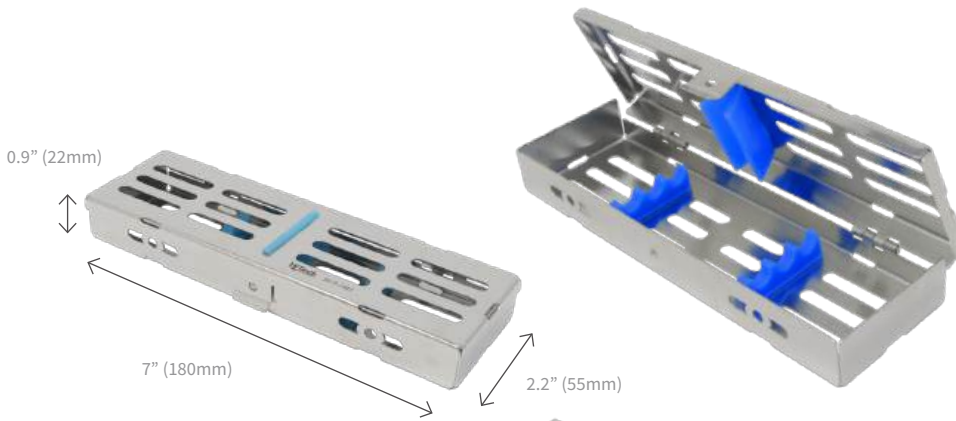
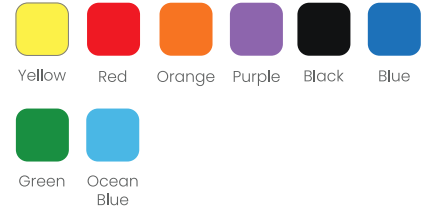

Exam Cassette for 5 Instruments

HMCT-1405 | \$89.99

Exterior Dimensions 7" x 2.8" x 0.9"
(180 mm x 70 mm x 22 mm)

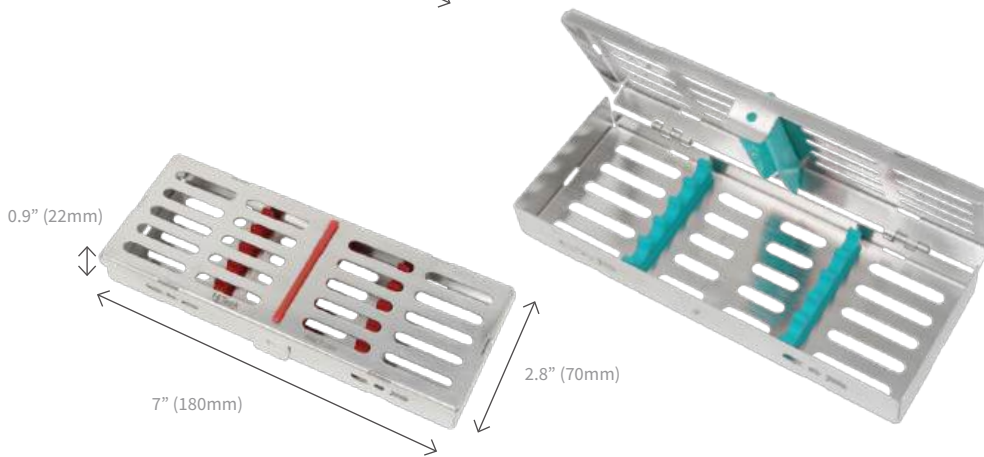
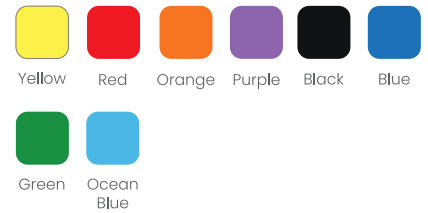

Small Cassette for 7 Instruments

HMCT-1407 | \$98.99

Exterior Dimensions 7" x 3.5" x 0.9"
(180 mm x 90 mm x 22 mm)

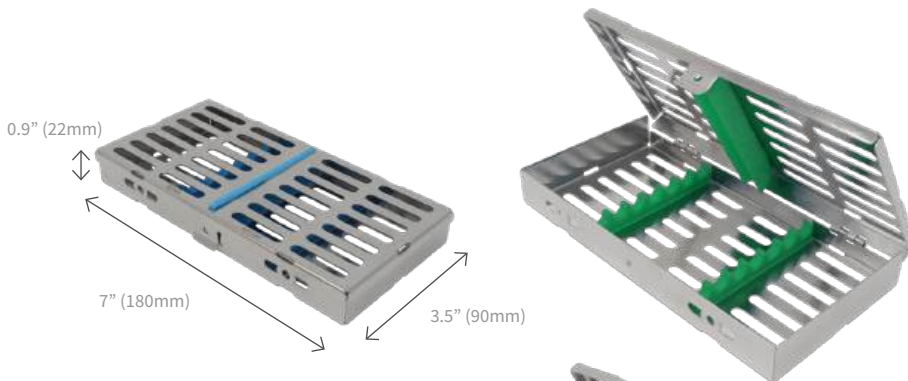
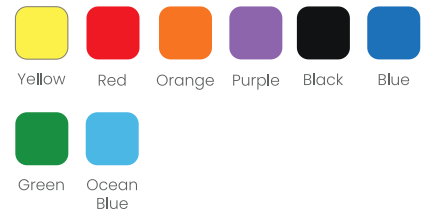

Small Cassette for 10 Instruments

HMCT-1410 | \$109.99

Exterior Dimensions 7" x 5.1" x 0.9"
(180 mm x 130 mm x 22 mm)

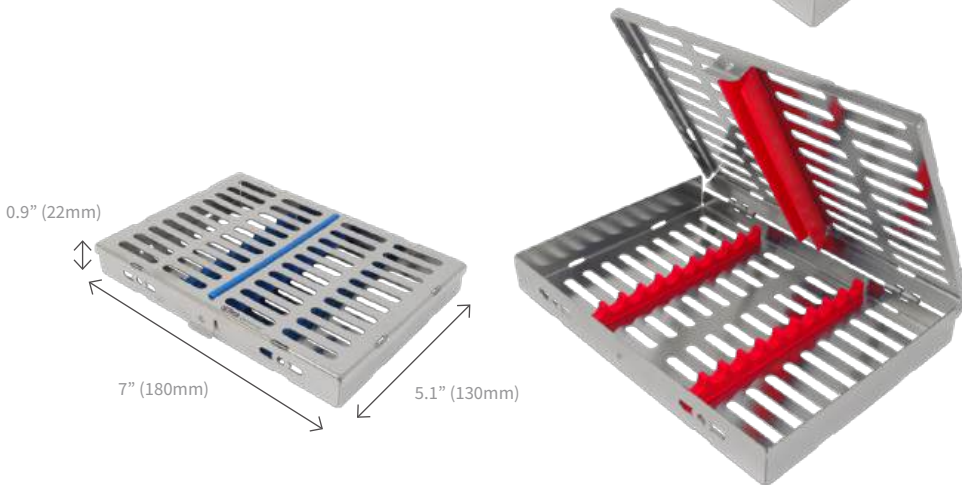
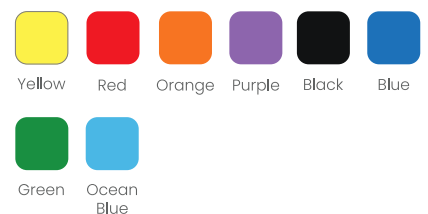

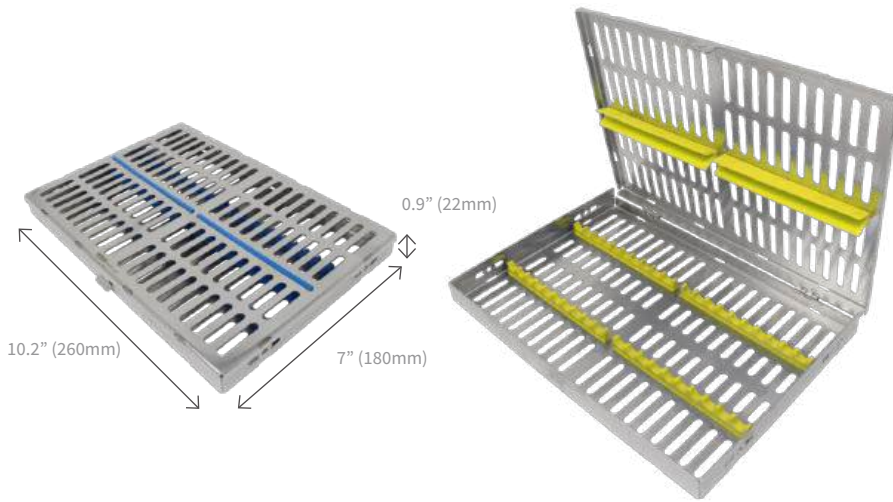

Large Cassette for 20 Instruments

HMCT-1420 | \$149.99

Exterior Dimensions 10.2" x 7" x 0.9"
(260 mm x 180 mm x 22 mm)

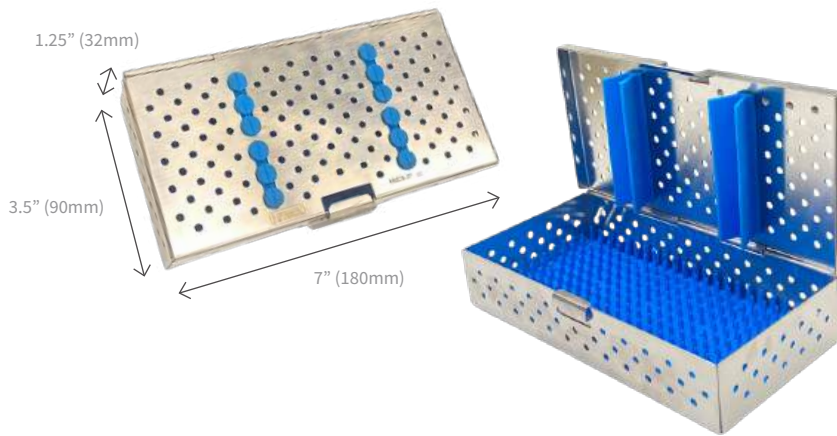
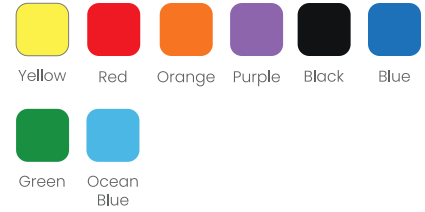

Cassette for Multiple Handpieces

CS7 | \$134.99

Exterior Dimensions 7" x 3.5" x 1.25"
(180 mm x 90 mm x 32 mm)



Small Ultrasonic Cassette

SUSTC1 | \$149.99

Exterior Dimensions 8" x 1.25" x 1.5"
(203 mm x 38 mm x 32 mm)

Cassette holds 2 Ultrasonic Inserts or 1 Handpiece



Medium Ultrasonic Cassette

MUSTC4 | \$169.99

Exterior Dimensions 8" x 3" x 1.25"
(203 mm x 76 mm x 32 mm)

Cassette holds up to 3 high-speed Handpieces or 5 Ultrasonic Inserts.

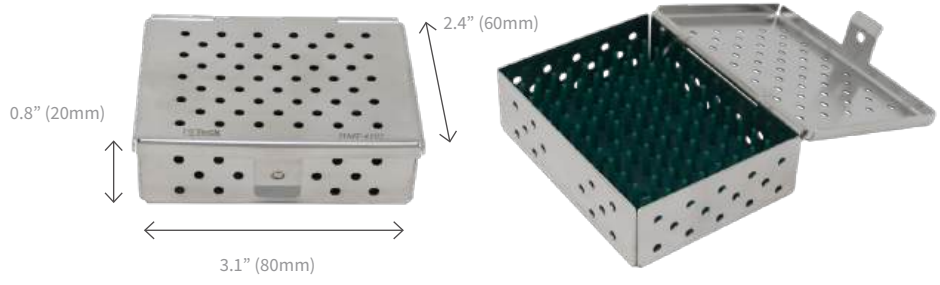

Small Parts Cassette - Size B

HMMT-4105 | \$74.99
 Exterior Dimensions 3.1" x 2.4" x 1"
 (80 mm x 60 mm x 20 mm)

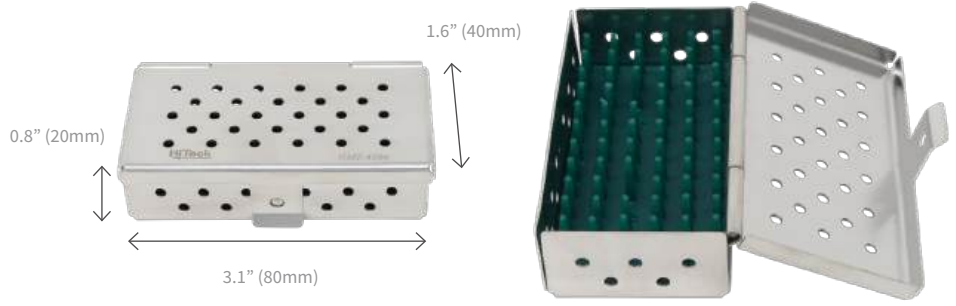

Small Parts Cassette - Size A

HMMT-4104 | \$69.99
 Exterior Dimensions 3.1" x 1.6" x 0.8"
 (80 mm x 40 mm x 20 mm)

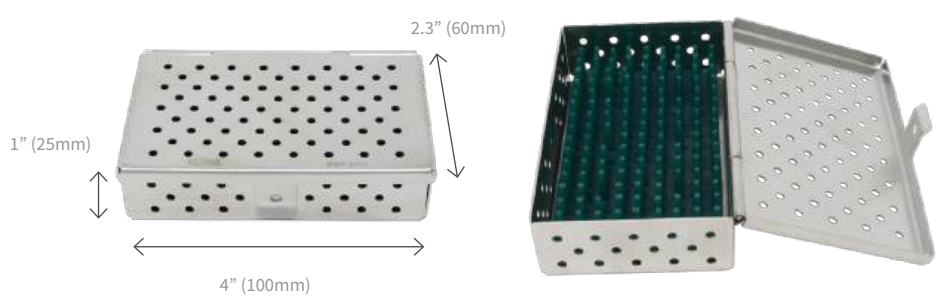

Small Parts Cassette - Size C

HMMT-4106 | \$74.99
 Exterior Dimensions 4" x 2.4" x 1"
 (100 mm x 60 mm x 25 mm)

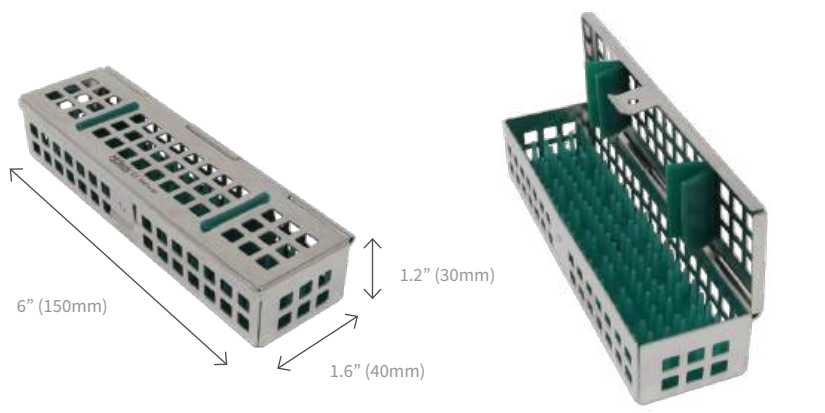

Single Handpiece Cassette

HMMT-4112 | \$84.99
 Exterior Dimensions 6" x 1.6" x 1.2"
 (150 mm x 40 mm x 30 mm)



Clip for Cassettes

AWCLIP | \$12.99
 Used to securely hold air water syringe tip and hinged instruments on the lid of the cassette.

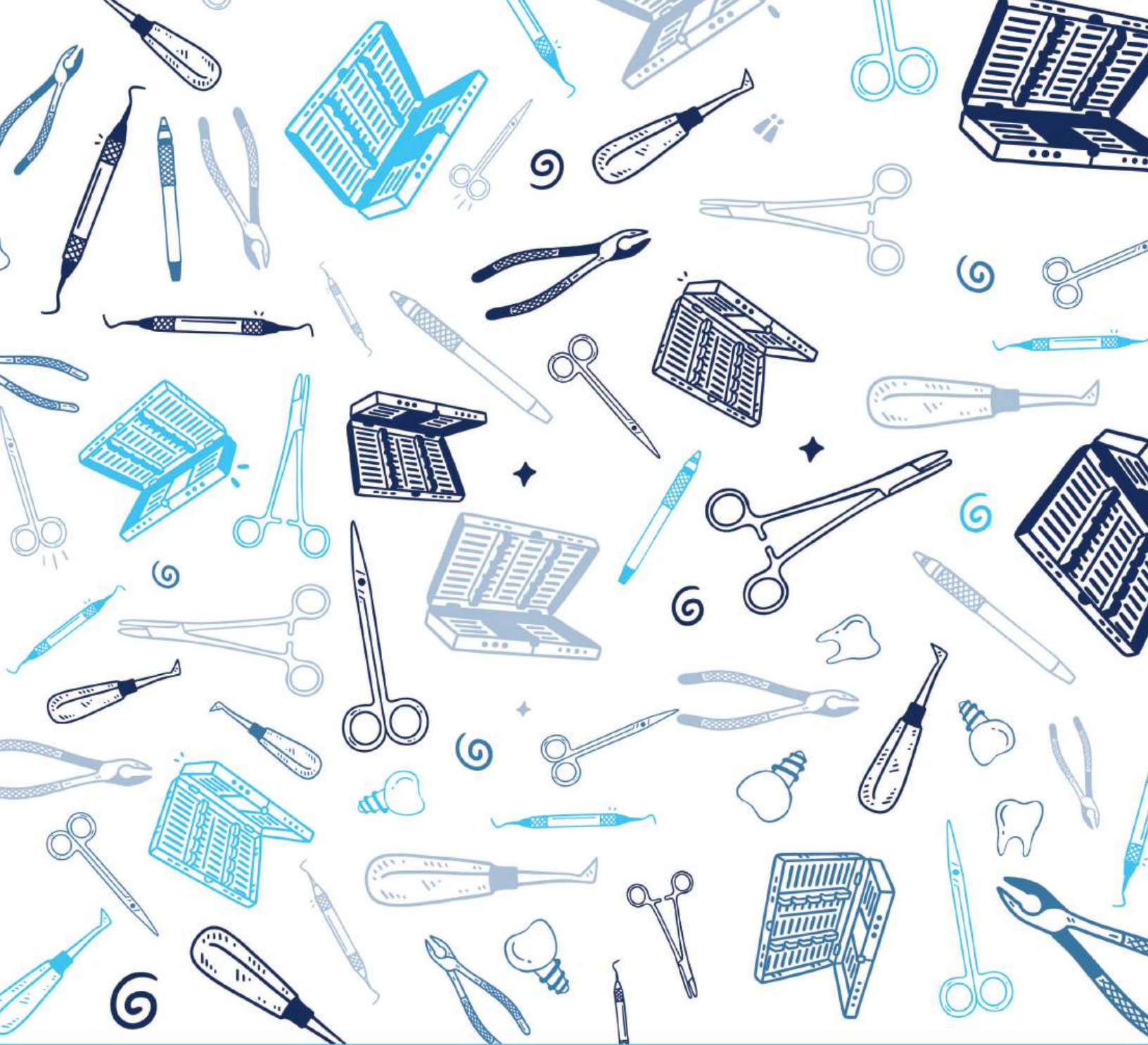

Copyright 2026 HiTeck Medical Instruments. All rights reserved.

The contents of this product catalog including but not limited to all text, photographs and graphics are the sole and exclusive property of HiTeck Medical Instruments and may not be copied, reproduced or distributed without prior written permission.

HiTeck reserves the right to change features of products, prices, images and text at any time without notice.



Your Partner in Dentistry

To learn more about HiTeck's Products & Services visit hiteckmedical.com

Sales & Support: 877.899.1861

Fax: 888.891.9792

Manufacturer: 2-4170 Sladeview Cres Mississauga, ON L5L 0A1 | Canada